

Internet 3.0:

The Next Generation Internet

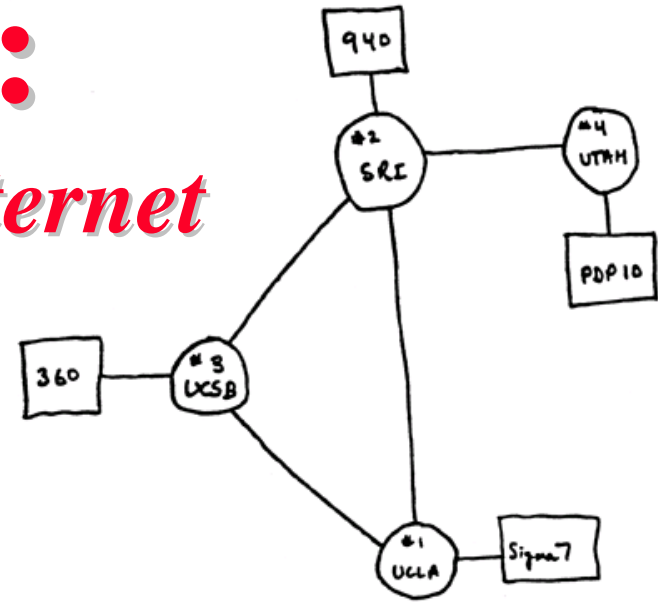

Raj Jain

Washington University in Saint Louis
Saint Louis, MO 63130

Jain@wustl.edu

Networking Architecture Symposium, Ascona, Switzerland
January 15-20, 2009

These slides and Audio/Video recordings of this talk are at:

http://www.cse.wustl.edu/~jain/talks/in3_na.htm



1. 12 Networking technologies that failed and why?
2. Life cycle of Technologies
3. What is Internet 3.0?
4. What problems in the current Internet do we need to fix?
5. How?

Acknowledgement: Our Internet 3.0 research is sponsored by grants from Intel Research Council and Huawei Technologies.

Networking: Failures vs Successes

- ❑ 1980: Broadband (vs baseband)
- ❑ 1984: ISDN (vs Modems)
- ❑ 1986: MAP/TOP (vs Ethernet)
- ❑ 1988: OSI (vs TCP/IP)
- ❑ 1991: DQDB
- ❑ 1994: CMIP (vs SNMP)
- ❑ 1995: FDDI (vs Ethernet)
- ❑ 1996: 100BASE-VG or AnyLan (vs Ethernet)
- ❑ 1997: ATM to Desktop (vs Ethernet)
- ❑ 1998: ATM Switches (vs IP routers)
- ❑ 1998: MPOA (vs MPLS)
- ❑ 1999: Token Rings (vs Ethernet)
- ❑ 2003: HomeRF (vs WiFi)
- ❑ 2007: Resilient Packet Ring (vs Carrier Ethernet)

Technology alone does not mean success.

Jain's Seven Requirements for Success

1. Low Cost: Low startup cost \Rightarrow Evolution
 \Rightarrow Each customer must save.
2x cost \Rightarrow 10x performance
Critical mass technologies (social networking)
have lower chances of success.
2. Killer Application (Video on demand)
3. Coexistence with legacy networks (Ethernet)
Existing infrastructure is more important than new technology
 \Rightarrow Even legacy name is important (FDDI vs. 100M Ethernet)
4. Timely completion (OSI)
5. Promised Performance (FDDI)
6. Manageability
7. Interoperability



IPv6

- ❑ 1993-1994: IPng
- ❑ 1995: RFC2710 – 1st RFC with IPv6 in title
- ❑ Requirements for Success
 1. ~~Low-Cost~~: Dual Stack
Critical mass technology
 2. ~~Killer Applications~~
 3. ~~Coexistence with legacy networks~~
 4. Timely completion
 5. Promised Performance?
 6. Manageability
 7. Interoperability

Life Cycle of Technologies

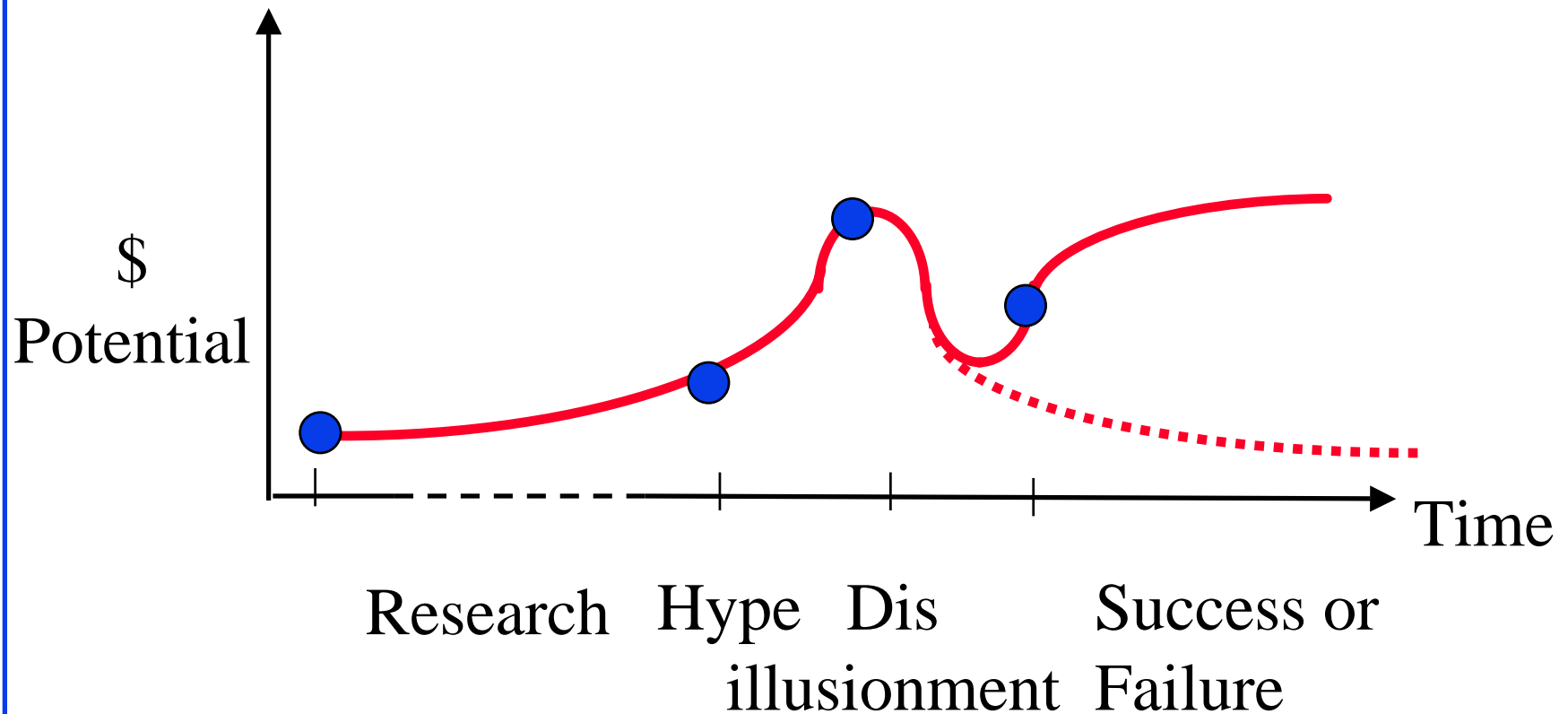

Life Cycle of Internetworking

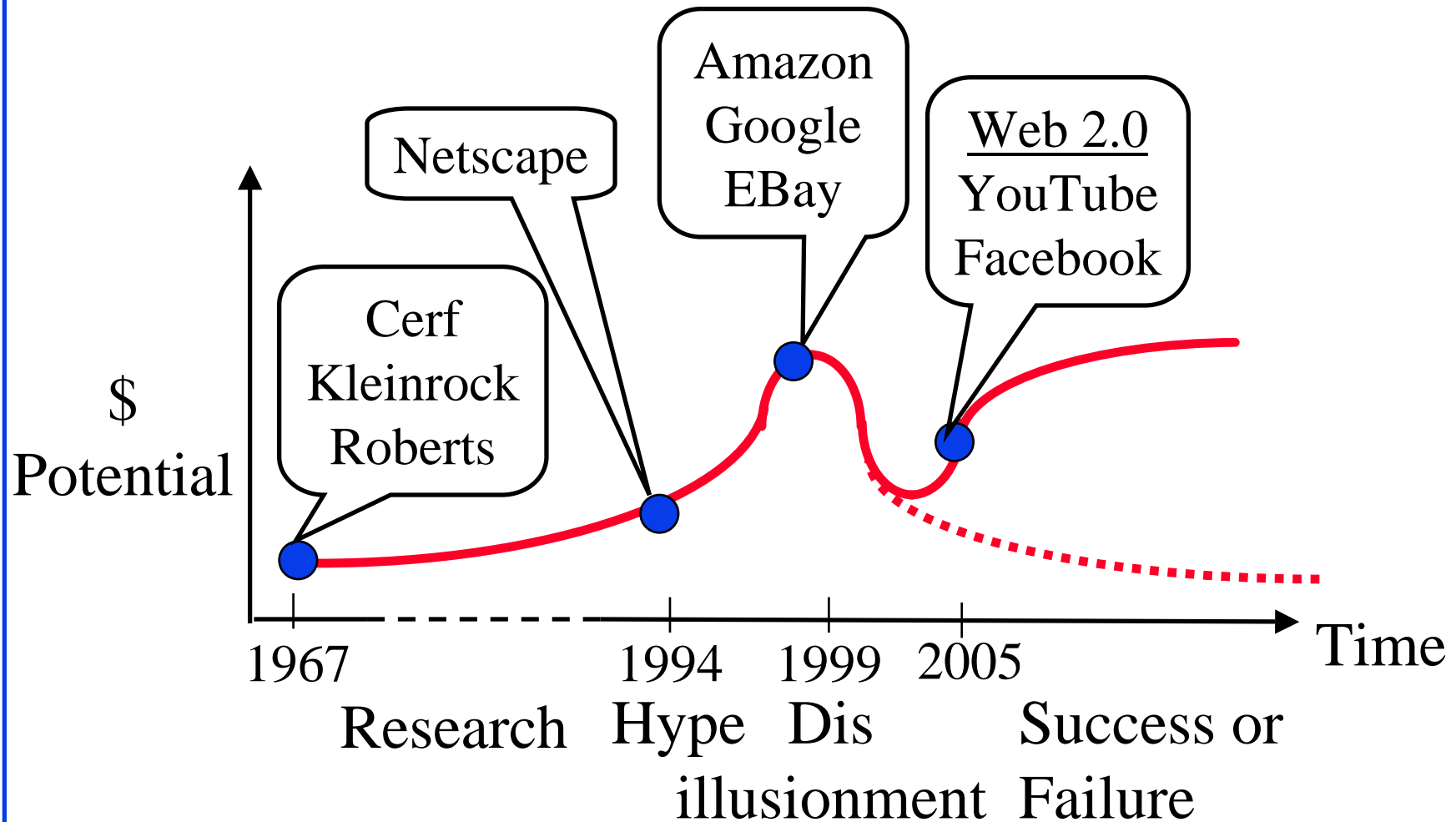

Networking Hype Cycle 2007

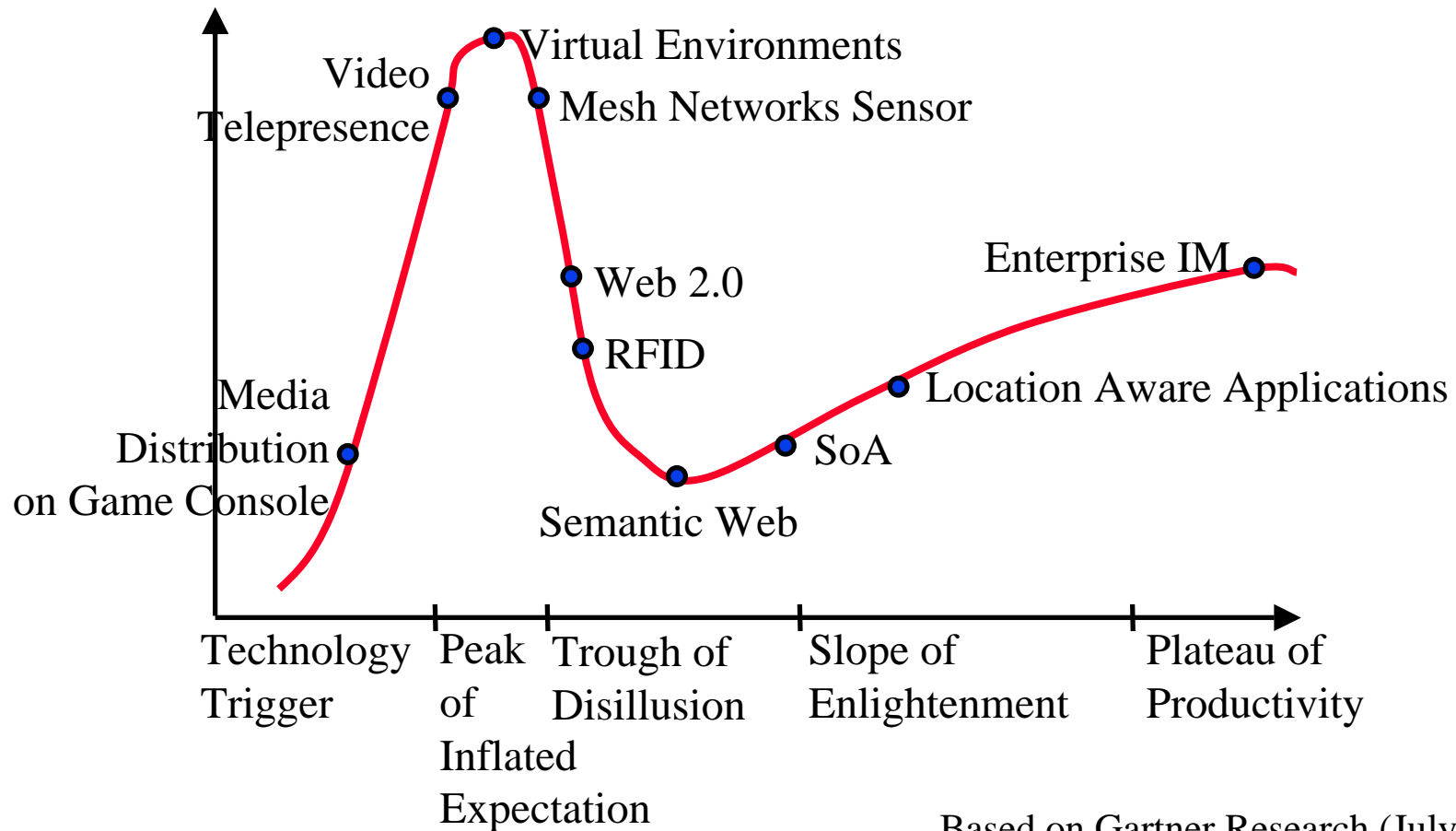

Based on Gartner Research (July 2007)

Internet Architecture Shifts

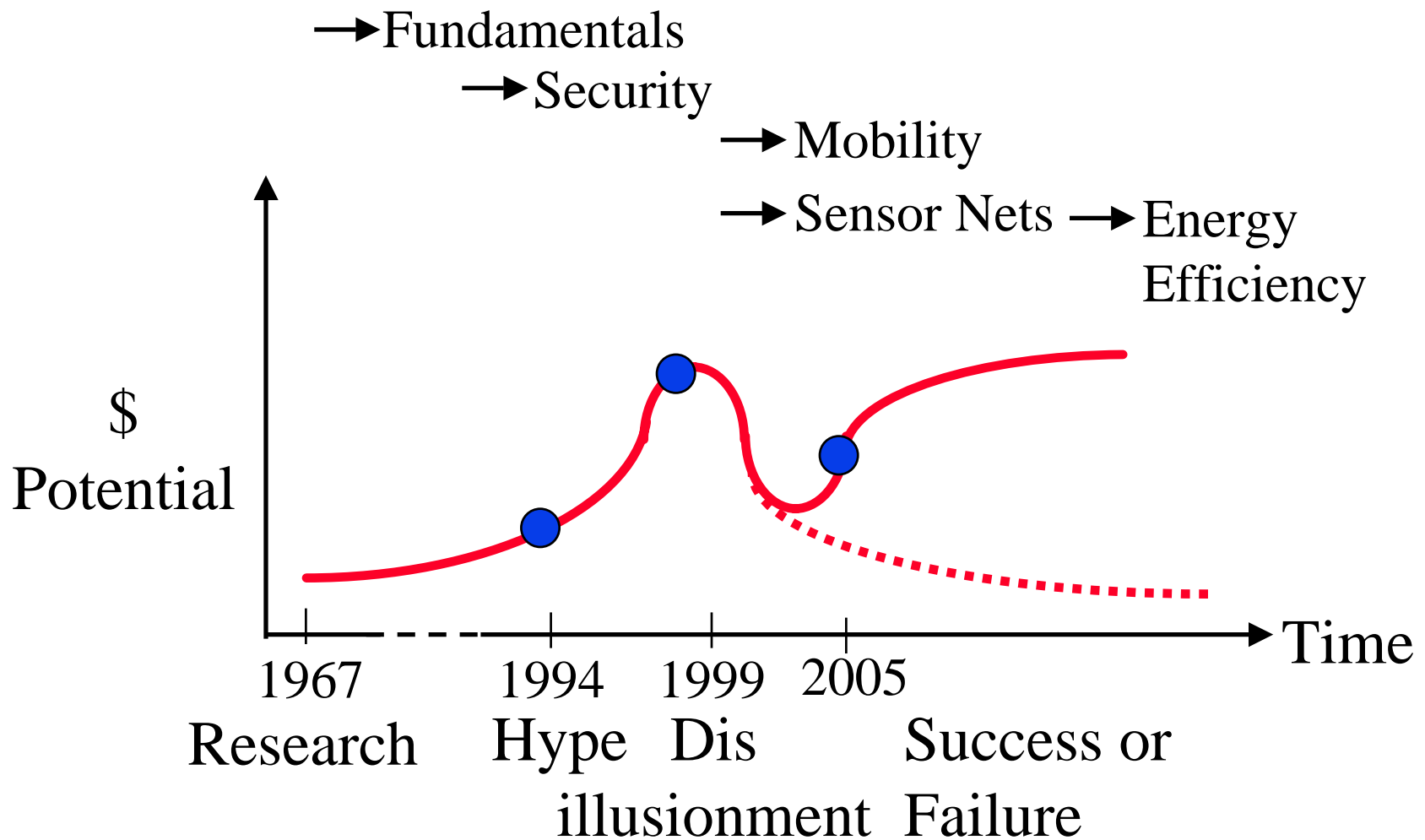

Internet 3.0

- ❑ “Next Generation Internet” is in a hype phase among research funding agencies across the globe: USA (NSF, DOE, DARPA), Europe, Japan, ...
- ❑ Past Hypes: Optical Networks (2000), Sensor networks (2002)
- ❑ Internet 3.0 is the name of the Washington University project on the next generation Internet
- ❑ Named by me along the lines of “Web 2.0”
- ❑ Internet 3.0 is more intuitive than GENI/FIND

Internet Generations

❑ Internet 1.0 (1969 – 1989) – Research project

- RFC1 is dated April 1969.
- ARPA project started a few years earlier
- IP, TCP, UDP
- Mostly researchers
- Industry was busy with proprietary protocols: SNA, DECnet, AppleTalk, XNS

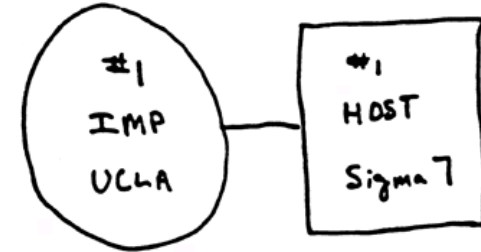

❑ Internet 2.0 (1989 – Present) – Commerce ⇒ new requirements

- Security RFC1108 in 1989
- NSFnet became commercial
- Inter-domain routing: OSPF, BGP,
- IP Multicasting
- Address Shortage IPv6
- Congestion Control, Quality of Service,...

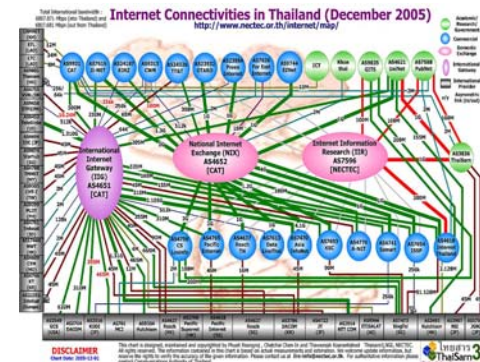

Key Problems with Current Internet

1. Designed for research
⇒ Trusted systems
Used for Commerce
⇒ Untrusted systems
In 1967 Security was not an issue.
2. Difficult to represent
organizational, administrative
hierarchies and relationships.
Perimeter based.
⇒ Difficult to enforce
organizational policies

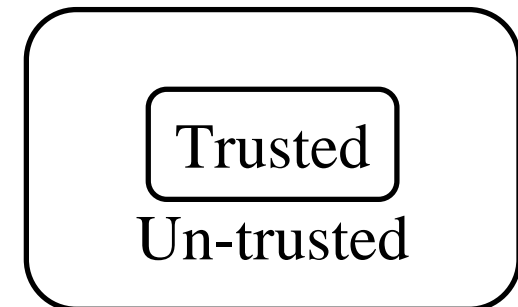

Problems (cont)

3. Identity and location in one (IP Address)
Makes mobility complex.
4. No representation for real end system: the human

Ref: See our Milcom 2006 paper
for a complete list of problems



Realms

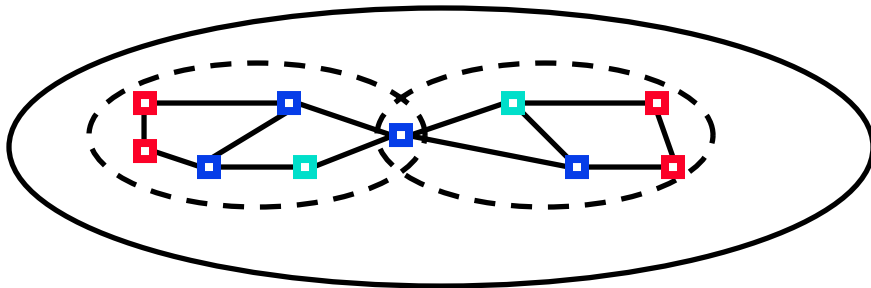

- ❑ Object names and Ids are defined within a realm
- ❑ A realm is a **logical** grouping of objects under an administrative domain
- ❑ The Administrative domain may be based on Trust Relationships
- ❑ A realm represents an organization
 - Realm managers set policies for communications
 - Realm members can share services.
 - Objects are generally members of multiple realms
- ❑ Realm Boundaries: Organizational, Governmental, ISP, P2P,...

Realm = Administrative Group

Physical vs Logical Connectivity

- ❑ Physically and logically connected:
All computers in my lab
= Private Network,
Firewalled Network
- ❑ Physically disconnected but logically connected:
My home and office computers
- ❑ Physically connected but logically disconnected: Passengers on a plane,
Neighbors, Conference attendees sharing a wireless network, A visitor



Physical connectivity \neq Trust

Id-Locator Split Architecture (MILSA)

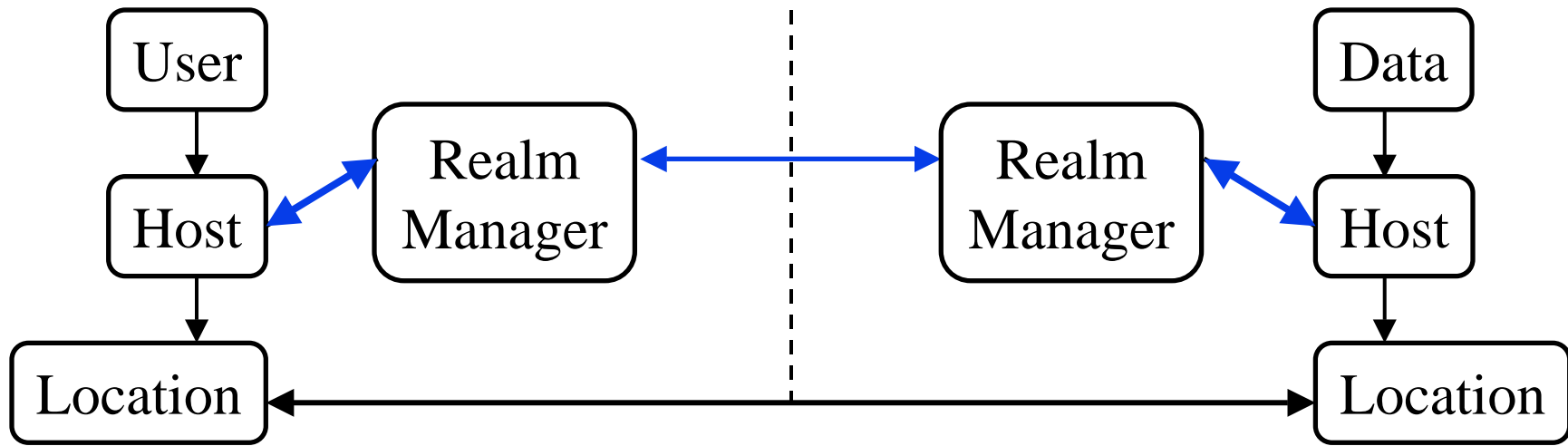

❑ Realm managers:

- Resolve current location for a given host-ID
- Enforce policies of authentication, authorization, privacy
- Allow mobility, multi-homing, location privacy

❑ Ref: Our Globecom 2008 paper [2]

ID to address translation function is too dynamic for DNS

User- Host- and Data Centric Models

- ❑ All discussion so far assumed host-centric communication
 - Host mobility and multihoming
 - Policies, services, and trust are related to hosts
- ❑ User Centric View:
 - Bob wants to watch a movie
 - Starts it on his media server
 - Continues on his iPod during commute to work
 - Movie exists on many servers
 - Bob may get it from different servers at different times or multiple servers at the same time
- ❑ Can we just give addresses to users and treat them as hosts?
No! ⇒ Policy Oriented Naming Architecture (PONA)



Policy Oriented Naming Architecture

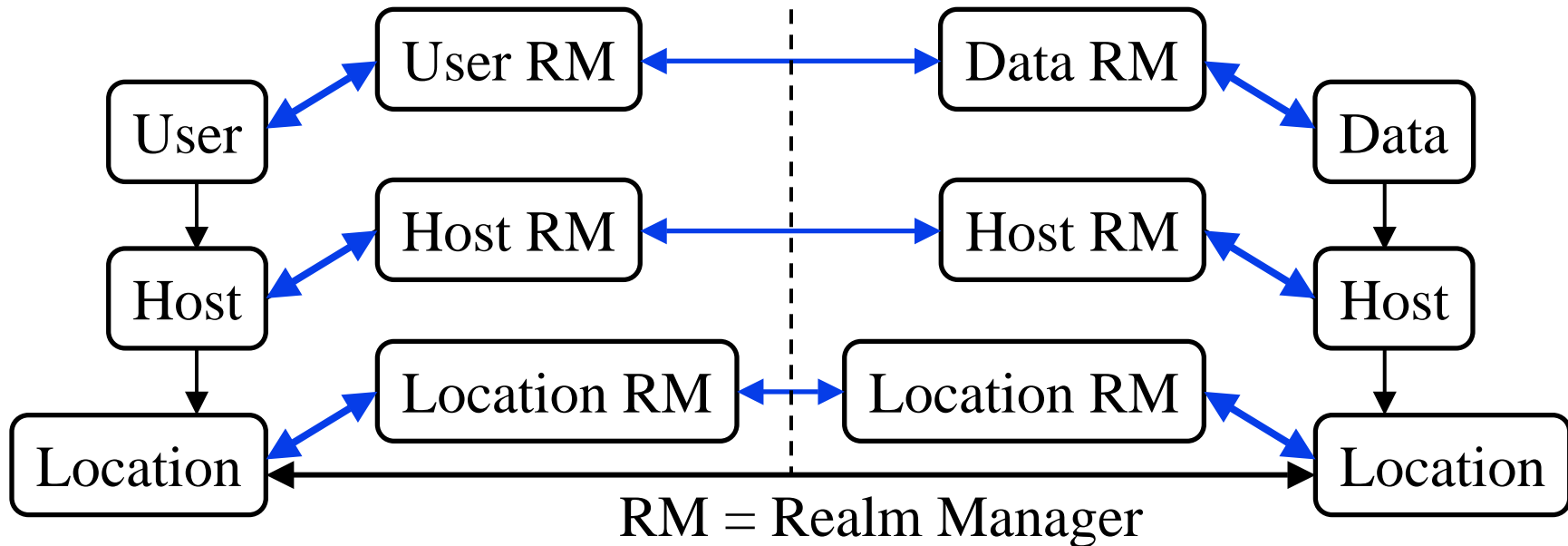

- ❑ Both Users and data need hosts for communication
- ❑ Data is easily replicable. All copies are equally good.
- ❑ Users, Hosts, Infrastructure, Data belong to different realms
- ❑ Each object has to follow its organizational policies.

Three tier-hierarchy with mobility and multi-homing in each tier.

Virtualizable Network Concept

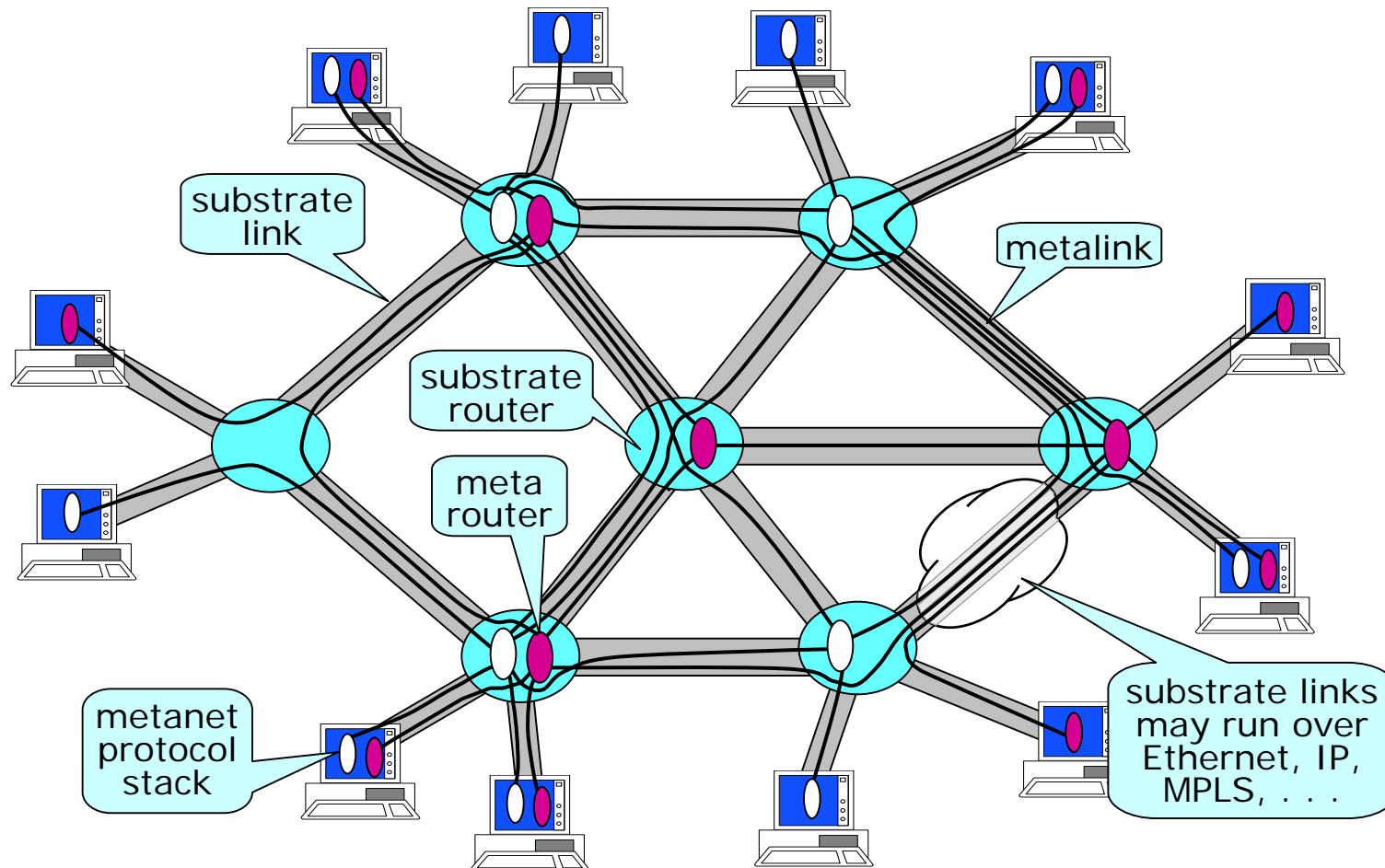

Ref: T. Anderson, L. Peterson, S. Shenker, J. Turner, "Overcoming the Internet Impasse through Virtualization," *Computer*, April 2005, pp. 34 – 41.

Realm Virtualization

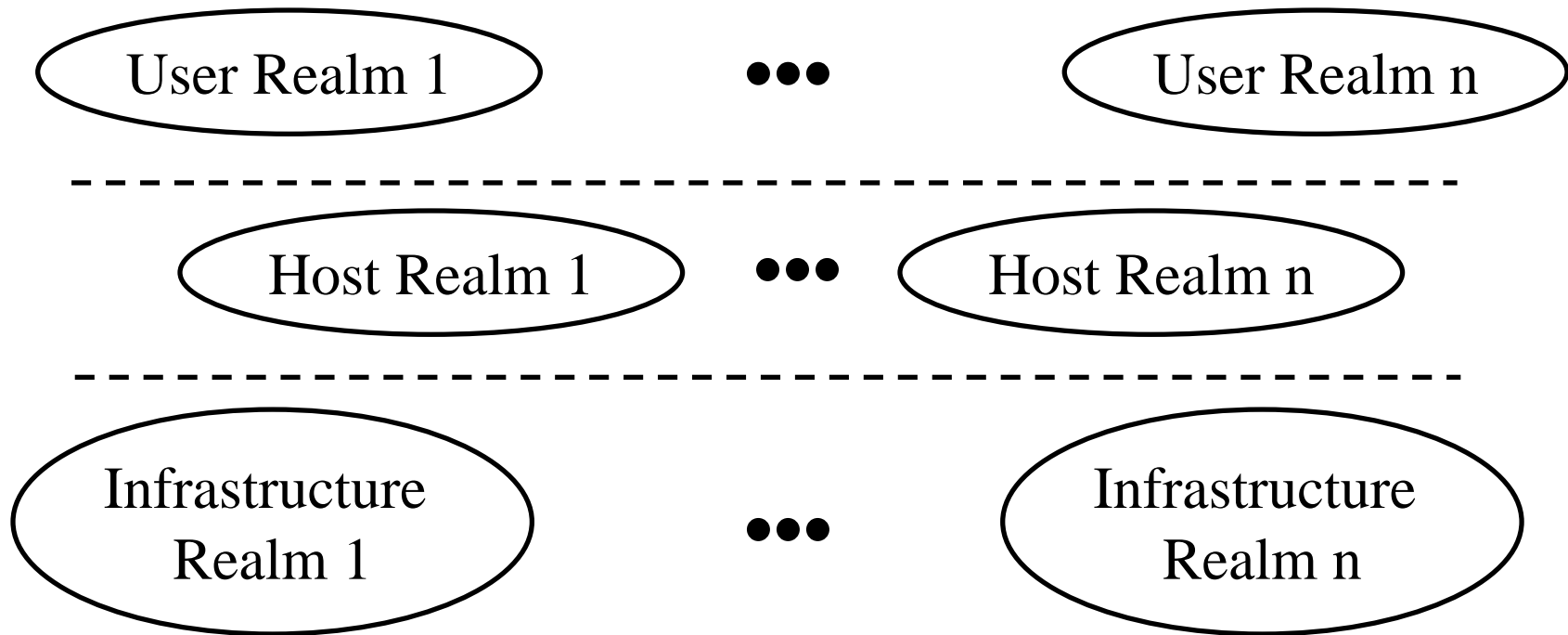

- ❑ Old: Virtual networks on a common infrastructure
- ❑ New: Virtual user realms on virtual host realms on infrastructure realms. E.g., Grid, Cellular ISPs

Need multi-level virtualization. Single level is past.

Routing Architecture for the Next Generation (RANGI)

- ❑ One level virtualization proposal. RRG draft, draft-xu-rangi-00
- ❑ Get host ID from the DNS. Get address from a realm server.
IDs belong to host organizations, addresses to service providers
- ❑ Hierarchical coding of ID indicates host ownership.
Addresses = provider aggregateable
- ❑ ID is 128-bit and can be treated as an IPv6 address by legacy hosts ⇒ Allows progressive transition
- ❑ RANGI solves: BGP routing table size growth problem, renumbering problem due to ISP change, mobility, multi-homing, traffic engineering, and source authentication.

**Ideas can be revolutionary (clean slate).
Implementation of those ideas has to be evolutionary.**

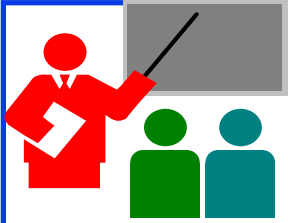

Summary

1. Seven Requirements for Technology Success: Low cost, killer application, performance, timely completion, coexistence, manageability, and interoperability
2. Life cycle of Technologies: fame/wealth.
3. Internet 3.0 is the next generation of Internet.
4. It must be secure, allow mobility, and be energy efficient.
5. Must be designed for commerce
⇒ Must represent multi-organizational structure and policies
6. Moving from host centric view to user-data centric view
⇒ Important to represent users and data objects
7. Need multi-tier virtualization
8. Ideas should be revolutionary but the implementation has to be evolutionary.

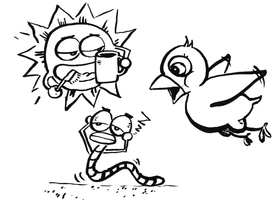

References

1. Jain, R., “Internet 3.0: Ten Problems with Current Internet Architecture and Solutions for the Next Generation,” in Proceedings of Military Communications Conference (MILCOM 2006), Washington, DC, October 23-25, 2006, <http://www.cse.wustl.edu/~jain/papers/gina.htm>
2. Subharthi Paul, Raj Jain, Jianli Pan, and Mic Bowman, “A Vision of the Next Generation Internet: A Policy Oriented View,” British Computer Society Conference on Visions of Computer Science, Sep 2008, <http://www.cse.wustl.edu/~jain/papers/pona.htm>
3. Jianli Pan, Subharthi Paul, Raj Jain, and Mic Bowman, “MILSA: A Mobility and Multihoming Supporting Identifier-Locator Split Architecture for Naming in the Next Generation Internet,,” Globecom 2008, Nov 2008, <http://www.cse.wustl.edu/~jain/papers/milsa.htm>

References (Cont)

- Jianli Pan, Raj Jain, Subharthi Paul, Mic Bowman, Shanzhi Chen, "Enhanced MILSA Architecture for Naming, Addressing, Routing and Security Issues in the Next Generation Internet," To appear in Proceedings of IEEE International Conference in Communications (ICC) 2009, Dresden, Germany, June 14-18, 2009, <http://www.cse.wustl.edu/~jain/papers/emilsa.htm>
- Xiaohu Xu, Raj Jain, "Routing Architecture for the Next Generation Internet (RANGI)," IRTF RRG Internet Draft, March 2009, <http://tools.ietf.org/html/draft-xu-rangi>