

Networking Protocols for Internet of Things

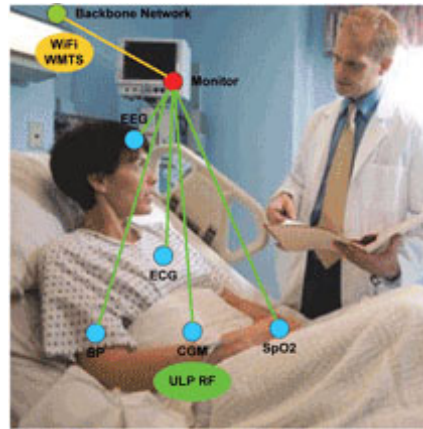

Raj Jain
Washington University in Saint Louis
Saint Louis, MO 63130
Jain@cse.wustl.edu

These slides and audio/video recordings of this class lecture are at:
<http://www.cse.wustl.edu/~jain/cse570-13/>



- ❑ 6LowPAN
 - Adaptation Layer
 - Address Formation
 - Compression
- ❑ RPL
 - RPL Concepts
 - RPL Control Messages
 - RPL Data Forwarding

Note: This is part 2 of a series of class lectures on IoT.
MQTT is covered in other parts.

IEEE 802.15.4

- ❑ Wireless Personal Area Network (WPAN)
- ❑ Allows mesh networking.
Full function nodes can forward packets to other nodes.
- ❑ A PAN coordinator (like WiFi Access Point) allows nodes to join the network.
- ❑ Nodes have 64-bit addresses
- ❑ Coordinator assigns 16-bit short address for use during the association
- ❑ Maximum frame size is 127 bytes
- ❑ More details in CSE 574 wireless networking course
<http://www.cse.wustl.edu/~jain/cse574-10/index.html>

6LowPAN

- ❑ IPv6 over Low Power Wireless Personal Area Networks (6LowPAN)
- ❑ To compress IPv6 header for low power IoT devices
- ❑ Issues:
 - Maximum Transmission Unit (MTU) at least 1280 bytes
IEEE 802.15.4 standard packet size is 127 bytes



- Address Resolution: 128b or 16B IPv6 addresses. 802.15.4 devices use 64 bit (no network prefix) or 16 bit addresses
- Optional mesh routing in datalink layer.
⇒ Need destination and intermediate addresses.
- MAC-level retransmissions versus end-to-end
- Similar issues apply to power line and fieldbus

Ref: G. Montenegro, et al., "Transmission of IPv6 Packets over IEEE 802.15.4 Networks," RFC 4944, Sep 2007, <http://tools.ietf.org/pdf/rfc4944>

Washington University in St. Louis

<http://www.cse.wustl.edu/~jain/cse570-13/>

©2013 Raj Jain

6LowPAN Adaptation Layer

- ❑ Optional hop-by-hop ack feature of 15.4 is used but the max number of retransmissions is kept low (to avoid overlapping L2 and L4 retransmissions)
- ❑ IPv6 Extension Headers: 8b *or less* dispatch \Rightarrow header type
 1. Mesh addressing header (2-bit dispatch=10)
 2. Hop-by-hop LowPAN Broadcast header (8-bit dispatch=01010000)
 3. Destination Processing Fragment header (5-bit dispatch=11100 or 11101)
- ❑ IPv6 address formation
- ❑ IPv6 and UDP compression headers

Frame Control	Seq. #	Adrs	[Security]	Disp bits	Ext Hdr	Disp bits	Ext Hdr	Disp bits	Ext Hdr	IPv6 Payload
2B	1B	0-20B	0-21B							

Mesh Addressing Header

- ❑ **Dispatch** = 10 (2 bits) \Rightarrow Mesh Addressing Header
- ❑ MAC header contains per-hop source and destination
- ❑ Original source and destination addresses are saved in Mesh addressing header
- ❑ A 4-bit hops-left field is decremented at each hop

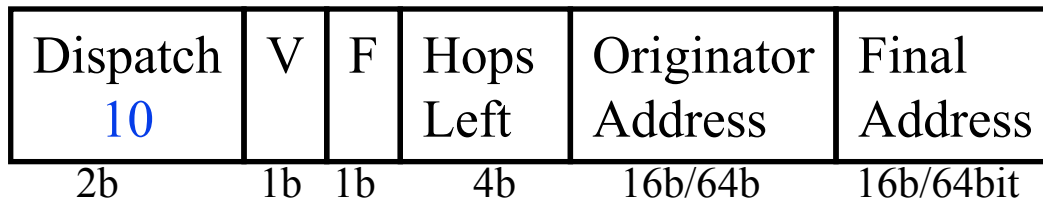
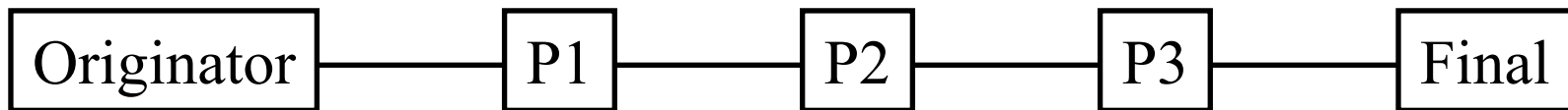

F=0 \Rightarrow Final address is EUI64, F=1 \Rightarrow 16-bit

V=0 \Rightarrow Originator address is EUI64, V=1 \Rightarrow 16bit

6LowPAN Broadcast Header

- ❑ For Mesh broadcast/multicast
- ❑ A new sequence number is put in every broadcast message by the originator

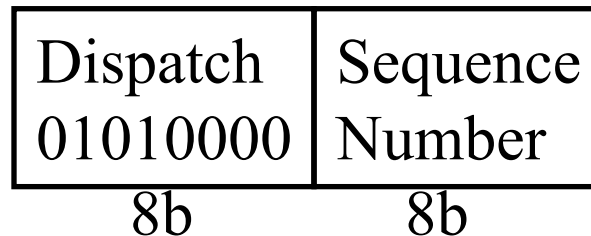

6LowPAN Fragment Header

- ❑ Dispatch = 11x00 (5 bits) \Rightarrow Fragment Header
- ❑ Full packet size in the first fragment's fragment header
- ❑ Datagram tag = sequence number
 \Rightarrow Fragments of the same packet
- ❑ Fragment Offset in multiples of 8 bytes

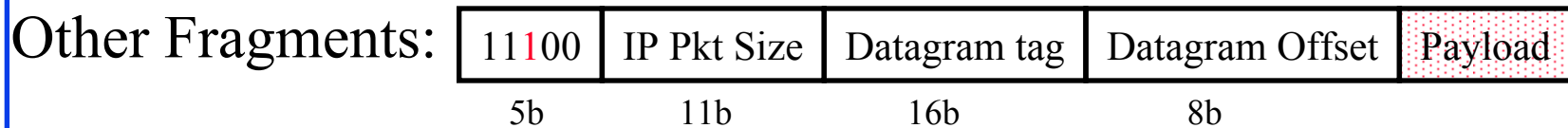
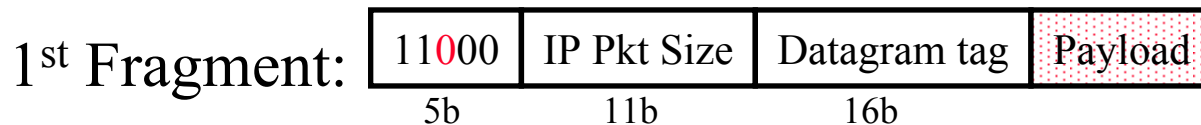

Address Formation

- ❑ **Ethernet addresses:** 48 bit MAC

Unicast Multicast	Universal Local	Organizationally Unique ID (OUI)	Manufacturer Assigned
1b	1b	22b	24b

- ❑ **IEEE 802.15.4 Addresses:** 64 bit Extended Unique Id (EUI)

Unicast Multicast	Universal Local	Organizationally Unique ID (OUI)	Manufacturer Assigned
1b	1b	22b	40b

- ❑ **Local bit** was incorrectly assigned. $L=1 \Rightarrow$ Local
but all-broadcast address = all 1's is not local
IETF RFC4291 changed the meaning so that $L=0 \Rightarrow$ Local
The 2nd bit is now called Universal bit (U-bit)
 \Rightarrow U-bit formatted EUI64 addresses
- ❑ **Link-Local IPv6 address** = FE80::U-bit formatted EUI64

Address Formation (Cont)

□ Example:

- EUI64 Local Address = 40::1 = 0100 0000::0000 0001
- U-bit formatted EUI64 = 0::1
- IPv6 Link-local address = FE80::1 = 1111 1110 1000 0000::1

□ IEEE 802.15.4 allows nodes to have 16-bit **short addresses** and each PAN has a 16-bit **PAN ID**.

1st bit of Short address and PAN ID is Unicast/Multicast

The 2nd bit of Short Address and PAN ID is Universal/Local.

You can broadcast to all members of a PAN or to all PANs.

□ IPv6 Link Local Address = FE80 :: PAN ID : Short Address

Use 0 if PAN ID is unknown.

2nd bit of PAN ID should always be zero since it is always local.

(2nd most significant = 6th bit from right)

Stateless Compression

- ❑ Called **HC1-HC2 compression** (not recommended)
- ❑ IP version field is omitted
- ❑ Flow label field if zero is omitted and C=1
- ❑ Only 4b UDP ports are sent if between 61616-61631 (F0Bx)
- ❑ UDP length field is omitted

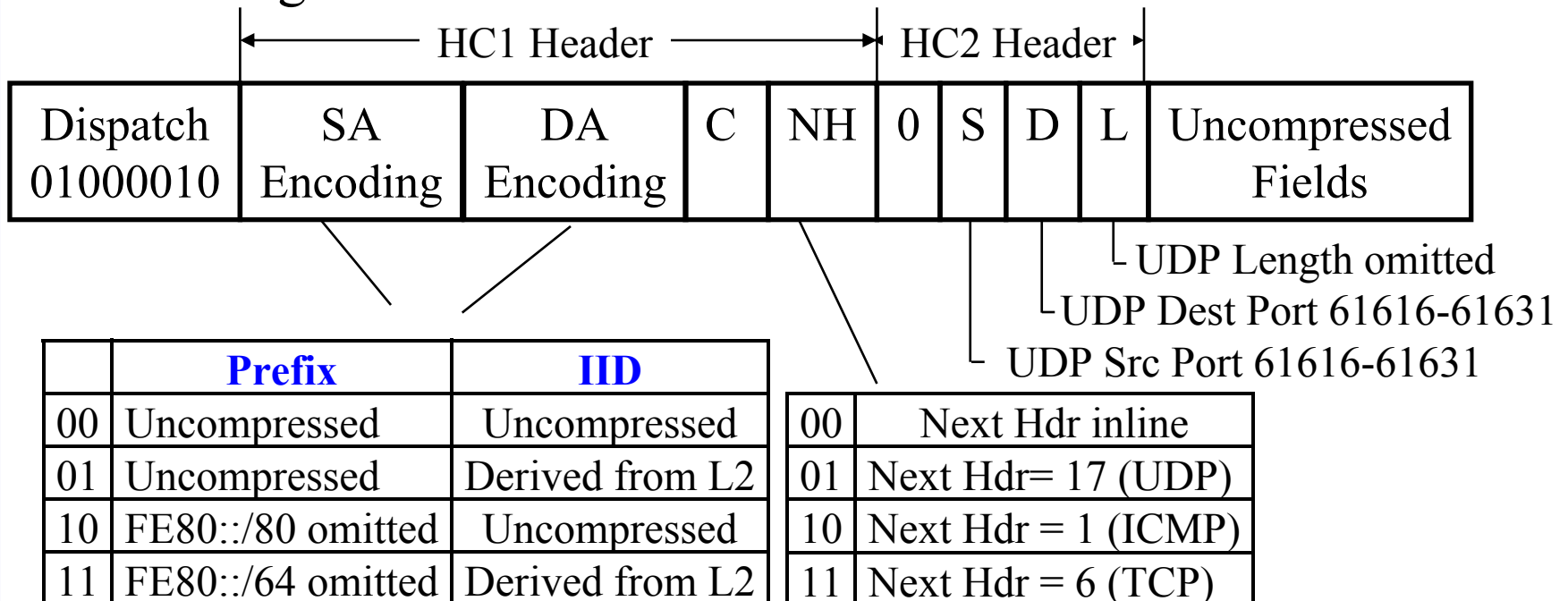

Context Based Compression

- ❑ HC1 works only with **link-local** addresses
- ❑ Need globally routable IPv6 addresses for outside nodes
- ❑ IPHC uses a 3b dispatch code and a 13-bit base header

Disp 011	TF	NH	Hop Limit	CID	SAC	SAM	M	DAC	DAM	SCI	DCI	Uncompressed IPv6 fields
-------------	----	----	--------------	-----	-----	-----	---	-----	-----	-----	-----	-----------------------------

3b 2b 1b 2b 1b 1b 2b 1b 1b 2b 4b 4b

Next Header uses LowPAN_NHC

Predefined hop limit = uncompressed (00), 1, 64, 255

Source Adr Mode Source/Dest Context IDs if CID=1

Source Adr Compression Multicast Destination

00	ECN+DSCP+4b pad+ 20b Flow label (4 Bytes)
01	ECN +2b pad + 12b Flow label (2 Bytes), DSCP omitted
10	ECN+DSCP (1B), Flow label omitted
11	ECN+DSCP+Flow label omitted

SAC DAC	SAM DAM	Address
0	00	No compression
0	01	First 64-bits omitted
0	10	First 112 bits omitted
0	11	128 bits omitted. Get from L2
1	00	Unspecified Address ::
1	01	First 64 bits from context
1	10	First 112 bits from context
1	11	128 bits from context and L2

Ref: O. Hersent, et al., "The Internet of Things: Key Applications and Protocols," Wiley, 2013, 344 pp., ISBN: 9781119994350 (Safari Book)

Washington University in St. Louis

<http://www.cse.wustl.edu/~jain/cse570-13/>

©2013 Raj Jain

Context Based Compression (Cont)

- ❑ If the next header uses LowPAN_NHC
 - For IPv6 base extension headers:

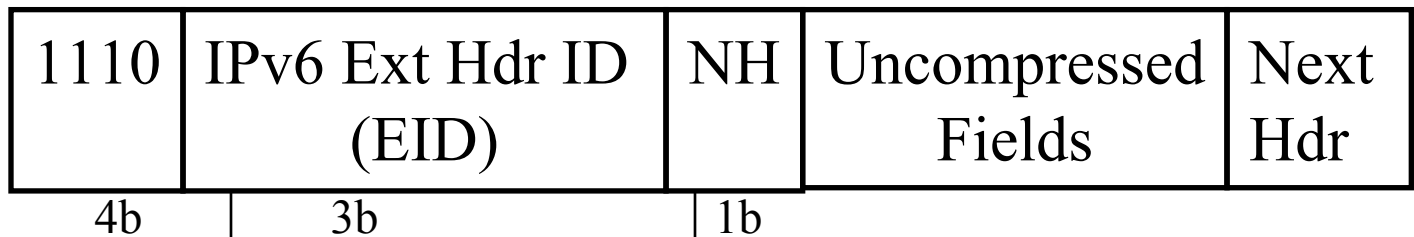

0 = Uncompressed
1 = LowPAN_NHC encoded

EID	Header
0	IPv6 Hop-by-Hop Options
1	IPv6 Routing
2	IPv6 Fragment
3	IPv6 Destination Options
4	IPv6 Mobility Header
5	Reserved
6	Reserved
7	IPv6 Header

LowPAN_NHC UDP Header:

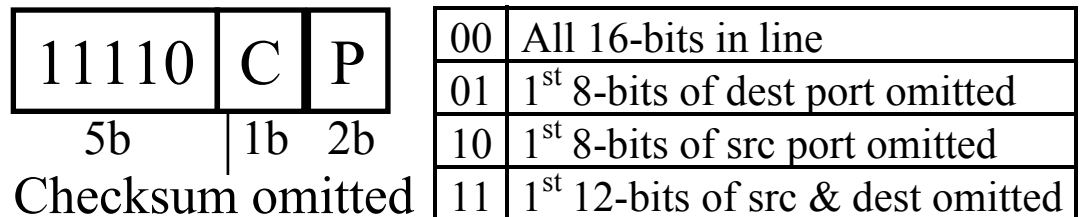

Ref: J. Hui and P. Thubert, "Compression Format for IPv6 Datagrams over IEEE 802.15.4-Based Networks," IETF RFC 6282, Sep 2011, <http://tools.ietf.org/pdf/rfc6282>

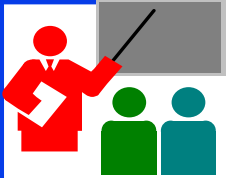

6LowPAN: Summary

❑ 3 New Headers:

- Mesh addressing: Intermediate addresses
- Hop-by-Hop: Mesh broadcasts
- Destination processing: Fragmentation

❑ **Address Formation:** 128-bit addresses by prefixing FE80::

❑ **Header compression:**

- HC1+HC2 header for link-local IPv6 addresses
- IPHC compression for all IPv6 addresses

Routing Protocol for Low-Power and Lossy Networks (RPL)

- ❑ Developed by IETF Routing over Low-Power and Lossy Networks (ROLL) working group
- ❑ Low-Power and Lossy Networks (LLN) Routers have constraints on processing, memory, and energy.
⇒ Can't use OSPF, OLSR, RIP, AODV, DSR, etc
- ❑ LLN links have high loss rate, low data rates, and instability
⇒ expensive bits, dynamically formed topology
- ❑ Covers both wireless and wired networks
Requires **bidirectional** links. May be symmetric/asymmetric
- ❑ Ideal for n-to-1 (**data sink**) communications, e.g., meter reading
1-to-n and 1-to-1 possible with some extra work.
- ❑ Multiple LLN instances on the same physical networks

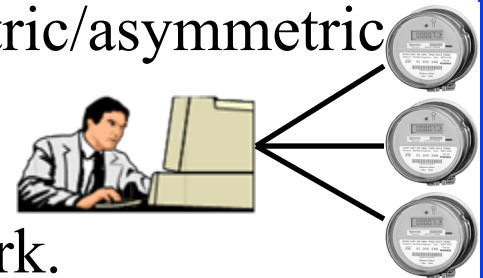

Ref: T. Winder, Ed., et al., "RPL: IPv6 Routing Protocol for Low-Power and Lossy Networks," IETF RFC 6550, Mar 2012,
<https://ietf.org/doc/rfc6550/>

RPL Concepts

- ❑ **Directed Acyclic Graph (DAG):** No cycles
- ❑ **Root:** No outgoing edge
- ❑ **Destination-Oriented DAG (DODAG):** Single root
- ❑ **Up:** Towards root
- ❑ **Down:** Away from root
- ❑ **Objective Function:** Minimize energy, latency, ...
- ❑ **Rank:** Distance from root using specified objective
- ❑ **RPL Instance:** One or more DODAGs.
A node may belong to multiple RPL instances.
- ❑ **DODAG ID:** IPv6 Adr of the root
- ❑ **DODAG Version:** Current version of the DODAG. Every time a new DODAG is computed with the same root, its version incremented.

DAG

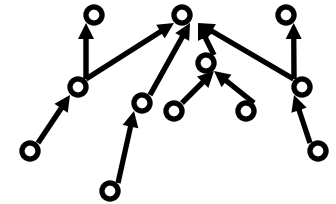

DODAG

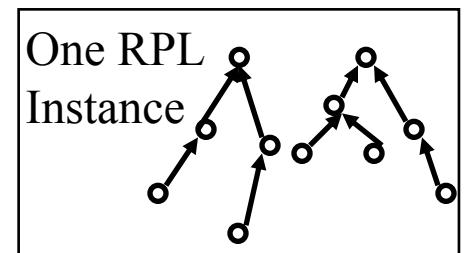
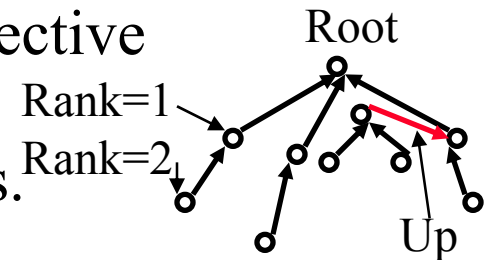

RPL Concepts (Cont)

- ❑ **Goal:** Reachability goal, e.g., connected to database
- ❑ **Grounded:** Root can satisfy the goal
- ❑ **Floating:** Not grounded. Only in-DODAG communication.
- ❑ **Parent:** Immediate successor towards the root
- ❑ **Sub-DODAG:** Sub tree rooted at this node
- ❑ **Storing:** Nodes keep routing tables for sub-DODAG
- ❑ **Non-Storing:** Nodes know only parent. Do not keep a routing table.

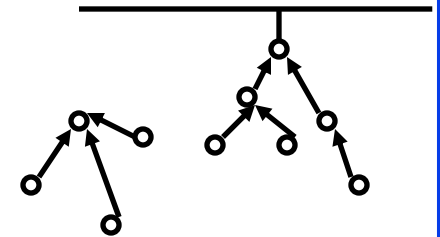

RPL Control Messages

1. DODAG Information Object (DIO):

- Downward RPL instance multicasts
- Allows other nodes to discover an RPL instance and join it

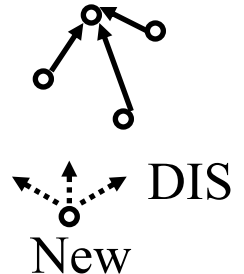

2. DODAG Information Solicitation (DIS):

- Link-Local **multicast** request for DIO (neighbor discovery).
Do you know of any DODAGs?

3. Destination Advertisement Object (DAO):

- From child to parents or root.
- Can I join you as a child on DODAG #x?

4. DAO Ack: Yes, you can! Or Sorry, you cant!

5. Consistency Check: Challenge/response messages for security

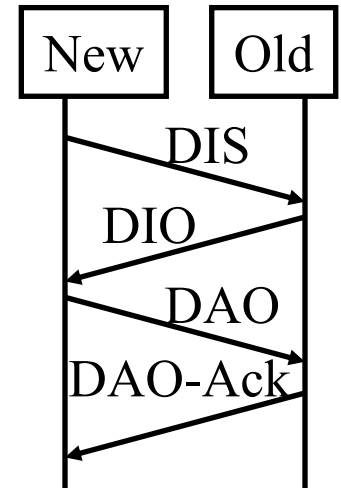

Ref: S. Kuryla, "RPL:IPv6 Routing Protocol for Low Power and Lossy Networks,"

<http://cnds.eecs.jacobs-university.de/courses/nds-2010/kuryla-rpl.pdf>

Washington University in St. Louis

<http://www.cse.wustl.edu/~jain/cse570-13/>

©2013 Raj Jain

DODAG Formation Example

1. A multicasts DIOs that it's member of DODAG ID itself with Rank 0.
2. B, C, D, E hear and determine that their rank (distance) is 1, 1, 3, 4, respectively from A
3. B, C, D, E send DAOs to A.
4. A accepts all
5. B and C multicast DIOs
6. D hears those and determines that its distance from B and C is 1, 2
7. E hears both B, C and determines that its distance from B and C is 2, 1
8. D sends a DAO to B
E sends a DAO to C
9. B sends a DAO-Ack to D
C sends a DAO-Ack to E

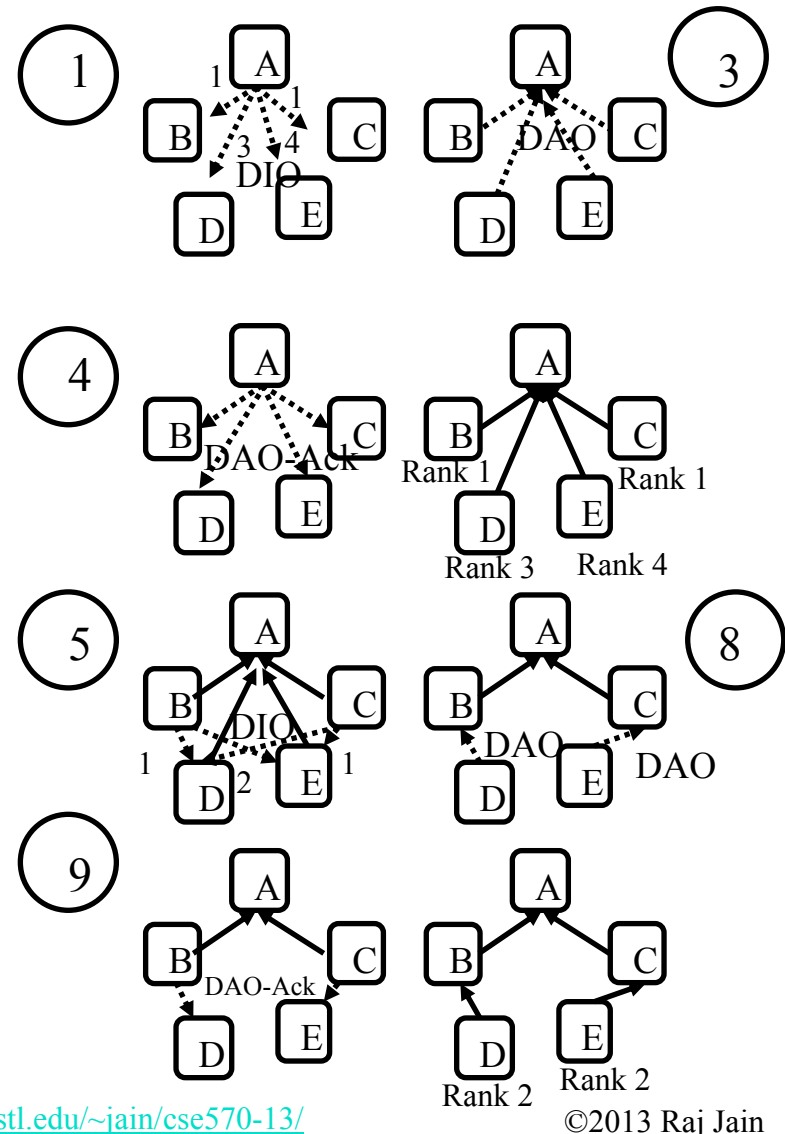

RPL Data Forwarding

- ❑ Case 1: To the root (n-to-1)
 - Address to root and give to parent
- ❑ Case 2: A to B
 - 2A: Storing (Everyone keeps a routing table)
 - ❑ Forward up from A to common parent
 - ❑ Forward down from common parent to B
 - 2B: Non-storing (No routing tables except at root)
 - ❑ Forward up from A to root
 - ❑ Root puts a source route and forwards down
- ❑ Case 2: Broadcast from the root (1-to-n)
 - 2A: Storing (everyone knows their children)
 - ❑ Broadcast to children
 - 2B: Non-Storing (Know only parents but not children)
 - ❑ Root puts a source route for each leaf and forwards

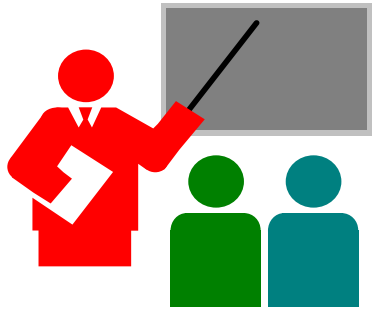

RPL Summary

1. An RPL instance consists of one or more DODAGs
2. DIO are broadcast downward,
DAOs are requests to join upward
DIS are DIO solicitations
DAO-ack are responses to DAO
3. Non-storing nodes do not keep any routing table and send everything upwards toward the root

Summary

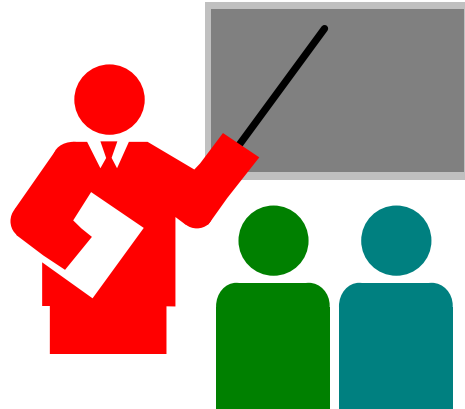

1. 6LowPAN is designed for IPv6 over IEEE 802.15.4
Frame size and address sizes are primary issues
Header compression is the key mechanism
2. RPL is designed primarily for data collection
No assumption about IEEE 802.15.4 or wireless or frame size
Routing is the primary issue
Forming a spanning tree like DODAG is the solution

Reading List

- ❑ O. Hersent, et al., “The Internet of Things: Key Applications and Protocols,” Wiley, 2013, 344 pp., ISBN: 9781119994350 (Safari Book)
- ❑ G. Montenegro, et al., “Transmission of IPv6 Packets over IEEE 802.15.4 Networks,” RFC 4944, Sep 2007, <http://tools.ietf.org/pdf/rfc4944>
- ❑ J. Hui and P. Thubert, “Compression Format for IPv6 Datagrams over IEEE 802.15.4-Based Networks,” IETF RFC 6282, Sep 2011, <http://tools.ietf.org/pdf/rfc6282>
- ❑ T. Winder, Ed., et al., "RPL: IPv6 Routing Protocol for Low-Power and Lossy Networks," IETF RFC 6550, Mar 2012, <https://ietf.org/doc/rfc6550/>
- ❑ S. Kuryla, “RPL: IPv6 Routing Protocol for Low Power and Lossy Networks,” <http://cnds.eecs.jacobs-university.de/courses/nds-2010/kuryla-rpl.pdf>

Wikipedia Links

- ❑ <http://en.wikipedia.org/wiki/6LoWPAN>
- ❑ http://en.wikipedia.org/wiki/IEEE_802.15.4
- ❑ http://en.wikipedia.org/wiki/MAC_address
- ❑ <http://en.wikipedia.org/wiki/IPv6>
- ❑ http://en.wikipedia.org/wiki/IPv6_address
- ❑ http://en.wikipedia.org/wiki/Organizationally_unique_identifier
- ❑ http://en.wikipedia.org/wiki/IPv6_packet
- ❑ http://en.wikipedia.org/wiki/Link-local_address

References

- ❑ N. Kushalnagar, et al., "IPv6 over Low-Power Wireless Personal Area Networks (6LoWPANs): Overview, Assumptions, Problem Statement, and Goals", IETF RFC 4919, Aug 2007, <http://www.rfc-editor.org/rfc/pdf/rfc4919.txt.pdf>
- ❑ E. Kim, et al., "Design and Application Spaces for IPv6 over Low-Power Wireless Personal Area Networks (6LoWPANs)," IETF RFC 6568, Apr 2012, <http://www.rfc-editor.org/rfc/pdf/rfc6568.txt.pdf>
- ❑ E. Kim, et al., "Problem Statement and Requirements for IPv6 over Low-Power Wireless Personal Area Network (6LoWPAN) Routing," IETF RFC 6606, May 2012, <http://www.rfc-editor.org/rfc/pdf/rfc6606.txt.pdf>
- ❑ Z. Shelby, et al., "Neighbor Discovery Optimization for IPv6 over Low-Power Wireless Personal Area Networks (6LoWPANs), IETF RFC 6775, Nov. 2012, <http://www.rfc-editor.org/rfc/pdf/rfc6775.txt.pdf>

References (Cont)

- ❑ "Routing Requirements for Urban Low-Power and Lossy Networks," IETF RFC 5548, May 2009, <https://ietf.org/doc/rfc5548/>
- ❑ "Industrial Routing Requirements in Low-Power and Lossy Networks," IETF RFC 5673, Oct 2009, <https://ietf.org/doc/rfc5673/>
- ❑ "Home Automation Routing Requirements in Low-Power and Lossy Networks," IETF RFC 5826, Apr 2010, <https://ietf.org/doc/rfc5826/>
- ❑ "Building Automation Routing Requirements in Low-Power and Lossy Networks," IETF RFC 5867, Jun 2010, <https://ietf.org/doc/rfc5867/>
- ❑ "The Trickle Algorithm," IETF RFC 6206, Mar 2011, <https://ietf.org/doc/rfc6206/>
- ❑ "RPL: IPv6 Routing Protocol for Low-Power and Lossy Networks," IETF RFC 6550, Mar 2012, <https://ietf.org/doc/rfc6550/>
- ❑ "Routing Metrics Used for Path Calculation in Low-Power and Lossy Networks," IETF RFC 6551, Mar 2012, <https://ietf.org/doc/rfc6551/>
- ❑ "Objective Function Zero for the Routing Protocol for Low-Power and Lossy Networks (RPL)," IETF RFC 6552, Mar 2012, <https://ietf.org/doc/rfc6552/>

References (Cont)

- ❑ "The Minimum Rank with Hysteresis Objective Function," IETF RFC 6719, Sep 2012, <https://ietf.org/doc/rfc6719/>
- ❑ "Reactive Discovery of Point-to-Point Routes in Low-Power and Lossy Networks," IETF RFC 6997, Aug 2013, <https://ietf.org/doc/rfc6997/>
- ❑ "A Mechanism to Measure the Routing Metrics along a Point-to-Point Route in a Low-Power and Lossy Network," IETF RFC 6998, Aug 2013, <https://ietf.org/doc/rfc6998/>

Acronyms

- ❑ 6LowPAN IPv6 over Low Power Wireless Personal Area Network
- ❑ AODV Ad-hoc On-demand Distance Vector
- ❑ CC Consistency Check
- ❑ DA Destination Address
- ❑ DAG Directed Acyclic Graph
- ❑ DAO DODAG Advertisement Object
- ❑ DIO DODAG Information Object
- ❑ DIS DODAG Information Solicitation
- ❑ DODAG Destination Oriented Directed Acyclic Graph
- ❑ DSR Dynamic Source Routing
- ❑ EUI Extended Unique Id
- ❑ HC Header Compression
- ❑ ICMP IP Control Message Protocol
- ❑ ID Identifier
- ❑ IEEE Institution of Electrical and Electronic Engineers

Acronyms (Cont)

- ❑ IETF Internet Engineering Task Force
- ❑ IID Interface Identifier
- ❑ IoT Internet of Things
- ❑ IP Internet Protocol
- ❑ IPHC IP Header Compression
- ❑ IPv6 Internet Protocol Version 6
- ❑ LLN Low-Power and Lossy Networks
- ❑ MAC Media Access Control
- ❑ MTU Maximum Transmission Unit
- ❑ OLSR On-Demand Link State Routing
- ❑ OSPF Open Shortest Path Forwarding
- ❑ PAN Personal Area Network
- ❑ RIP Routing Information Protocol
- ❑ ROLL Routing over Low-Power and Lossy Networks
- ❑ SA Source Address

Acronyms (Cont)

- ❑ TCP Transmission Control Protocol
- ❑ UDP User Datagram Protocol
- ❑ WiFi Wireless Fidelity
- ❑ WPAN Wireless Personal Area Network