

ATM Signaling

Raj Jain

Professor of Computer and Information Science

**Raj Jain is now at
Washington University in Saint Louis
Jain@cse.wustl.edu
<http://www.cse.wustl.edu/~jain/>**



- ❑ Types of signaling
- ❑ Call Endpoints: Address Formats
- ❑ Call setup/release
- ❑ Traffic Contract: Bandwidth, Quality of Service
- ❑ Signaling Mechanisms: Message formats

Signaling

- ❑ Signal = Control
- ❑ Signaling in telephone networks
= Control messages in computer networks
- ❑ Examples:
 - ❑ Connection setup request
= Off-hook signal from telephone to switch
 - ❑ Connection setup acknowledge = Dial tone
 - ❑ Destination address = Pulse or tone dialing
 - ❑ Destination busy = Busy tone
 - ❑ Destination Available = Ringing tone

Signaling Channel

- ❑ In-band signaling \Rightarrow Signaling over the same channel as payload
- ❑ Out-of-band signaling \Rightarrow Separate channels for signaling (but may be same physical circuits)
- ❑ Common Channel Signaling (CCS)
 - \Rightarrow Separate circuits for signaling
 - \Rightarrow Allows several new functions, such as 800

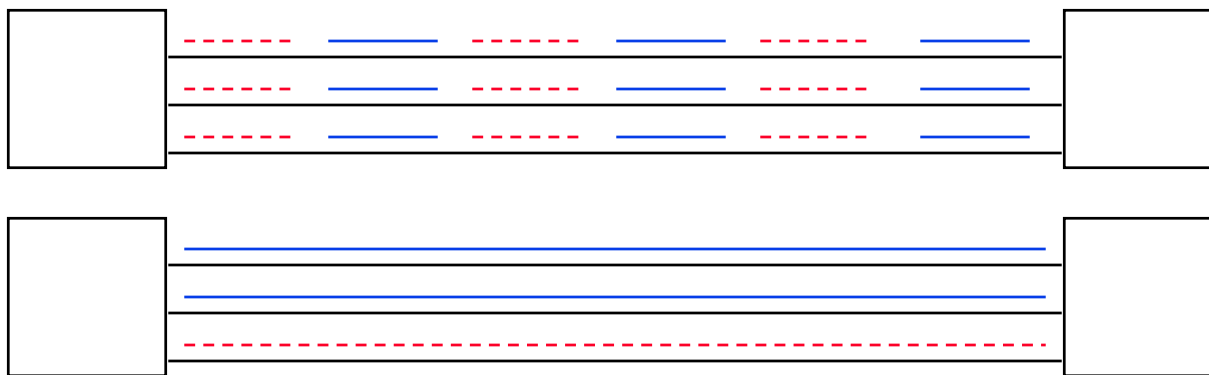

Signaling Modes

- ❑ Associated Mode: CCS follows the same path as payload
- ❑ Nonassociated Mode: CCS uses a separate network

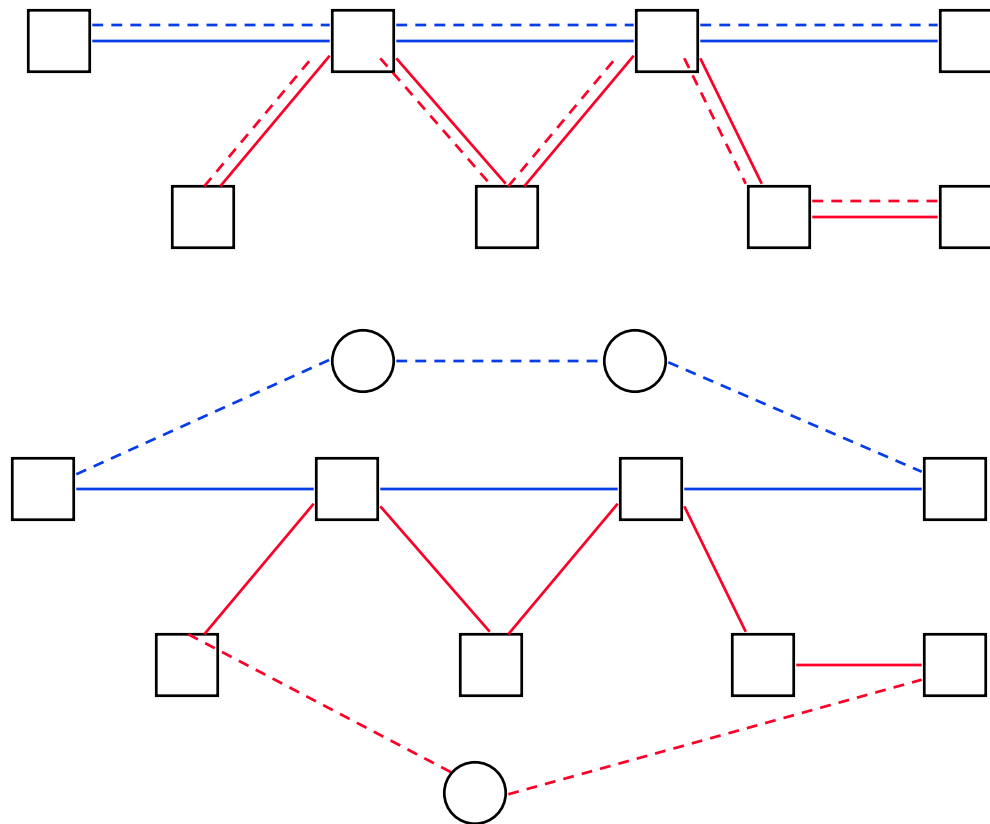

Signaling Standards

- ❑ Q.931 = Basic Call Control for ISDN
- ❑ Q.932 = Extends/uses Q.931 for supplementary services (call forwarding, etc)
- ❑ Q.933 = Q.931 Extension/subset for Frame-relay
- ❑ Signaling inside the network is more sophisticated than that between the network and the subscriber
- ❑ Digital Subscriber Signaling System 1 (DSS1)
= Call control signaling over the D channel
= Q.931 + Q.932 + lower layers
- ❑ Signaling System 7 (SS7) deals with inside the network while DSS1 deals with outside.
- ❑ Q.2931 = Q.93B = Basic Call Control for B-ISDN

Signaling Channels

- ❑ Reserved VPI/VCI
 - ❑ x/1 = Meta-signaling
 - ❑ x/2 = Broadcast signaling (not used initially)
 - ❑ 0/5 = ATM endpoint to local network signaling
 - both point-to-point and point-to-multipoint signaling
 - ❑ x/5 = point-to-point signaling with other endpoints and other networks

Meta-Signaling

- ❑ Used to setup signaling channels
- ❑ All meta-signaling messages are one cell long and have VPI/VCI = 0/1
- ❑ Sets up 3 types of signaling channels:
 - ❑ Point-to-point
 - ❑ General broadcast
 - ❑ Selective broadcast
- ❑ Procedures to:
 - ❑ Set up new signaling channels
 - ❑ Release channels
 - ❑ Verify channels

ATM Addresses

- ATM Forum specifies three NSAP-like address formats:
DCC ATM Format, ICD ATM Format, E.164 ATM Format
- NSAP = Network Service Access Point

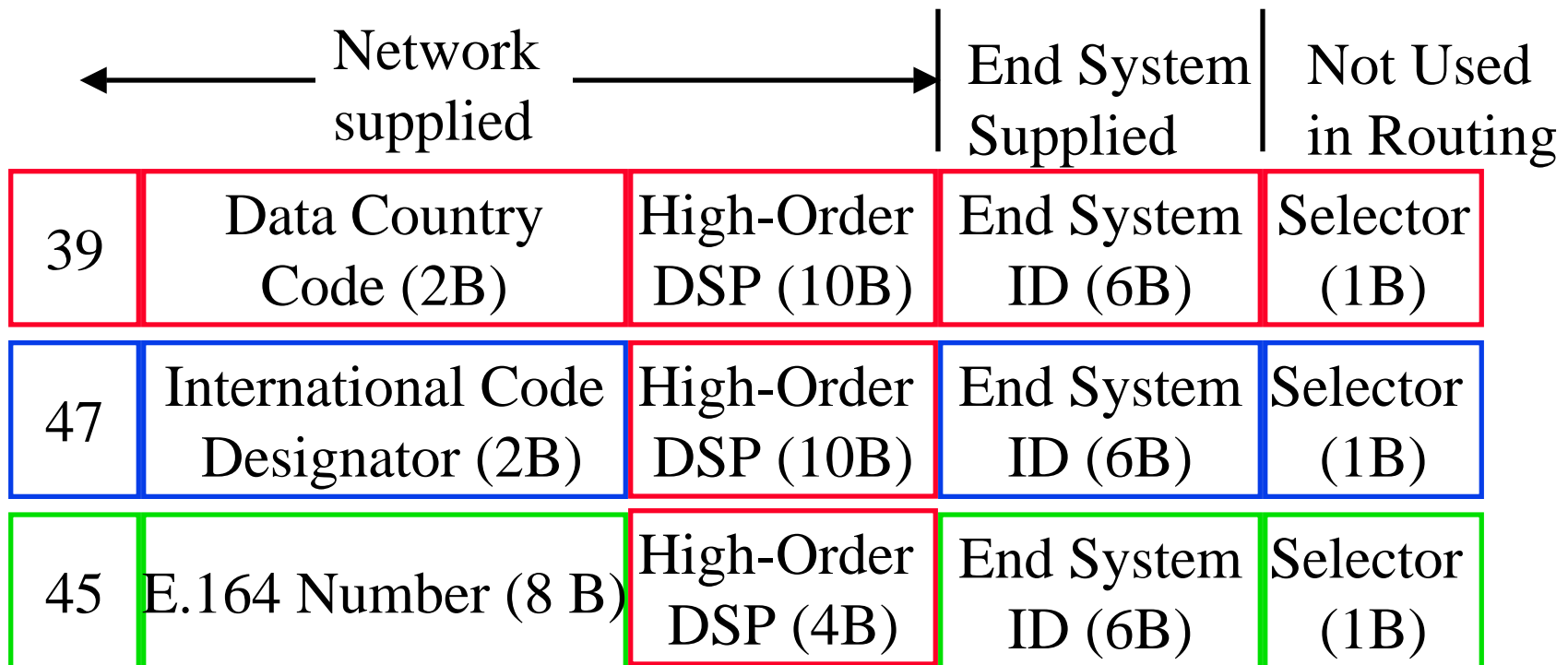

AFI Initial Domain Id

← Domain Specific Part (DSP) →

Addressing

- ❑ Authority and Format Identifier (AFI)
39 = ISO DCC, 47 = British Standards Institute ICD,
45 = ITU ISDN
- ❑ Initial Domain Identifier (IDI). Domain Specific Part (DSP)
- ❑ ISDN uses E.164 numbers (up to 15 BCD digits)
- ❑ ATM forum extended E.164 addresses to NSAP format.
E.164 number is filled with leading zeros to make 15 digits.
A F_{16} is padded to make 8 bytes. AFI and DSP are added.
- ❑ End System Identifier (ESI): 48-bit IEEE MAC address
- ❑ Selector is for use inside the host and is not used for routing.
- ❑ All ATM addresses are 20 bytes long.
- ❑ ATM forum removed the division of DSP into areas, etc.

- ❑ Private networks must support all three formats
Type of Number field = Unknown
Numbering Plan Indication field = ISO NSAP
- ❑ Public networks must support native E.164 and may optionally support three NSAP-encoded formats. For E.164:
Type of Number field = International number
Numbering Plan Indication field = Recommendation E.164
- ❑ If only native E.164 addresses, subaddress field in signaling messages used to convey private ATM address across.
- ❑ One Transit network selection possible using carrier identification code field.

E.164 Numbers

- ❑ North American Numbering Plan (NANP): 1(614)-555-1212
- ❑ E.163 numbering plan for telephony: 12 digits
- ❑ E164 numbering plan for ISDN: 15 digits
- ❑ Defined in ITU-T recommendation E.164 for ISDN
- ❑ ISDN numbers uniquely identify interfaces to public networks
- ❑ Several ISDN numbers can identify the same interface
- ❑ ISDN signaling allows ISDN number followed by a subaddress (extension) of upto 40 digits
- ❑ Administered by public networks
(Therefore, are not easily available for private network use)

NSAP is a Misnomer!

- ❑ NSAP = Network Service Access Point
Identifies network layer service entry
- ❑ SNPA = Subnetwork point of attachment
Identifies the interface to subnetwork
- ❑ SNPA address (or part of it) is used
to carry the packet across the network.
- ❑ CLNP uses NSAP to deliver the packet
to the right entity inside the host.
- ❑ ATM uses NSAP-like encoding
but ATM addresses identify SNPA
and not NSAP.

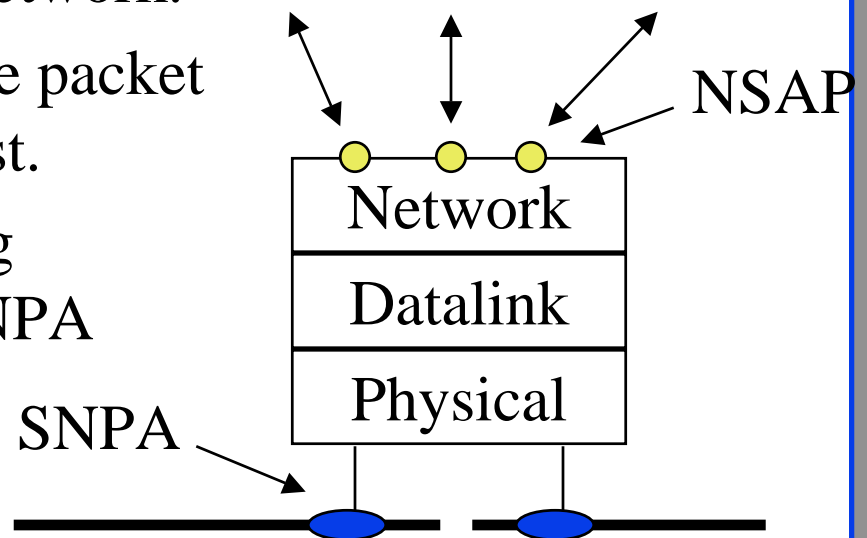

Address Registration

- User and switch register addresses using Interim Local Management Interface (ILMI)
= Simple Network Management Protocol (SNMP)

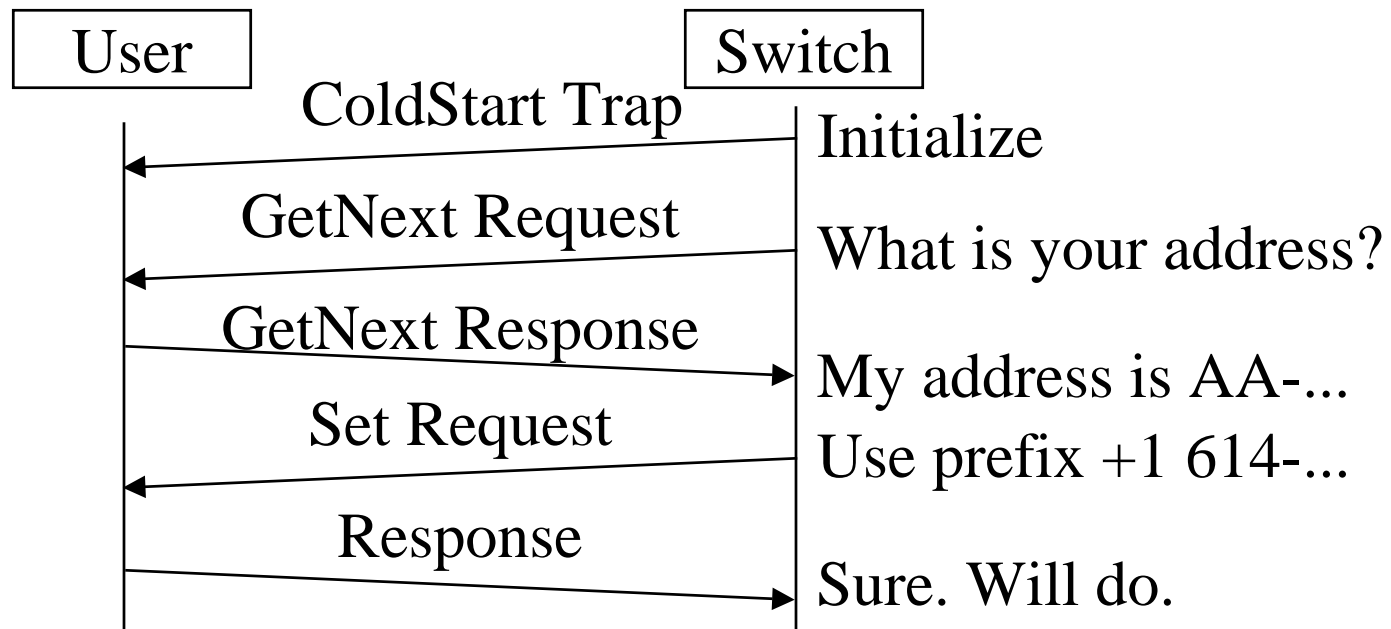

- Similar activities can occur in the reverse direction.

Connection Types

- ❑ Permanent and Switched
- ❑ Point to point
 - ❑ Symmetric or assymmetric bandwidth (Uni or bidirectional)
- ❑ Point-to-multipoint: Data flow in one direction only. Data replicated by network.
 - ❑ Leaf Initiated Join (LIJ) or non-LIJ

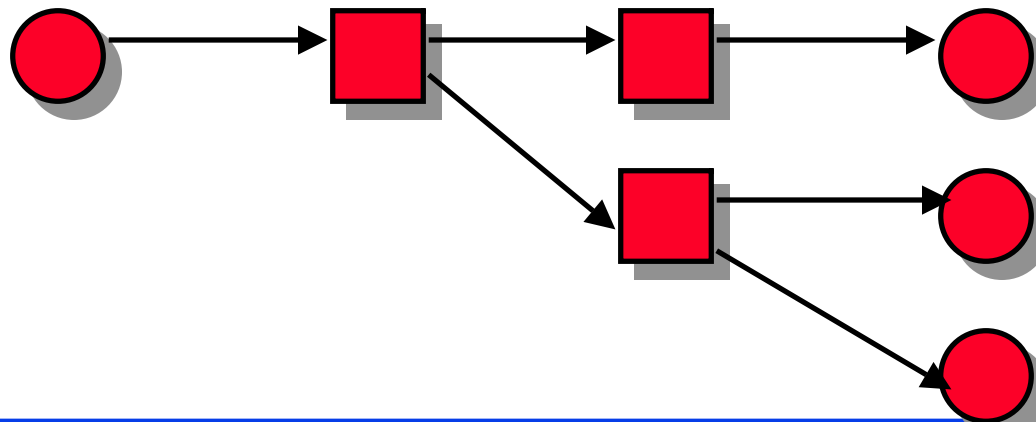

Connection Setup

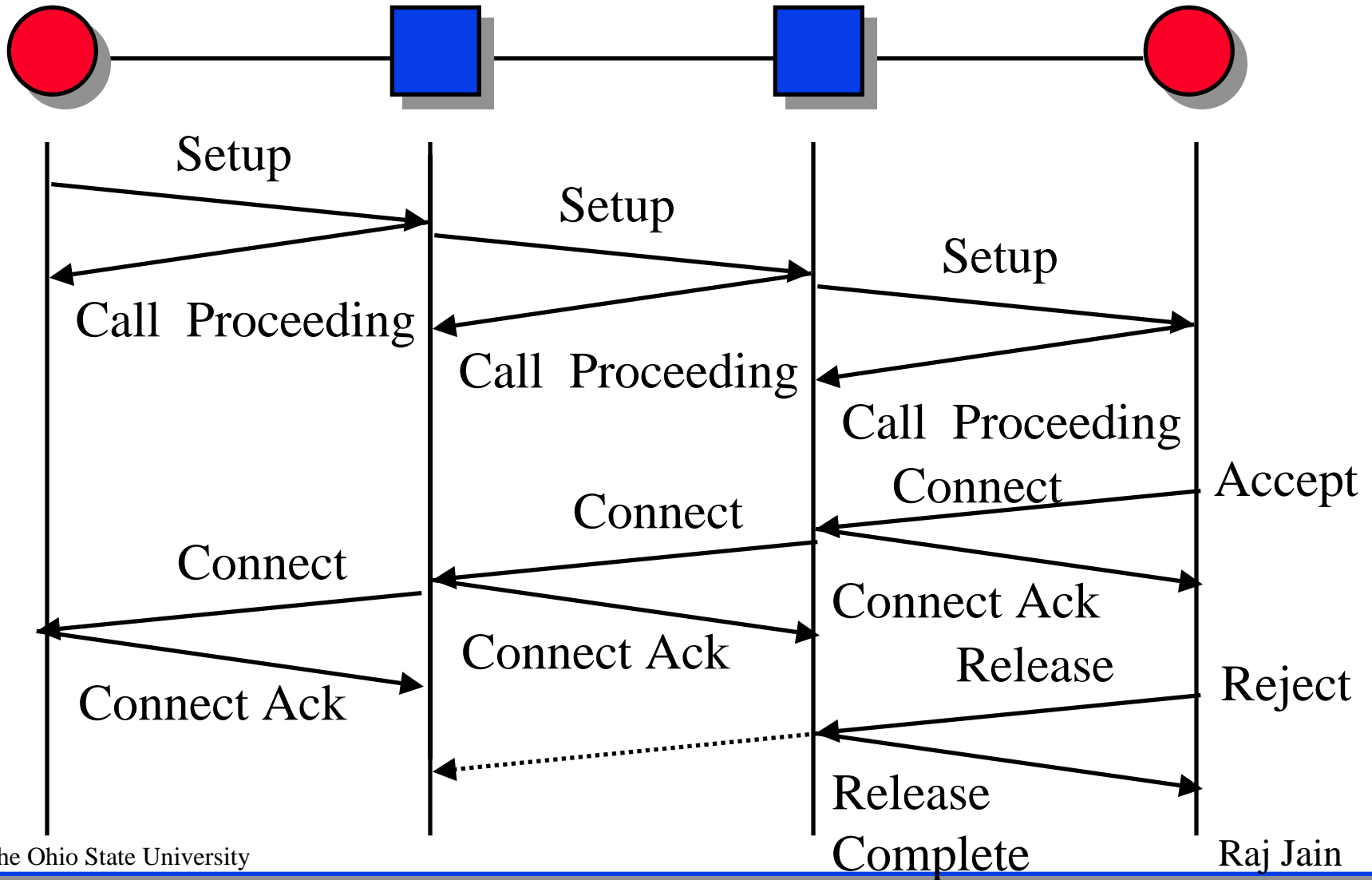

Connection Release

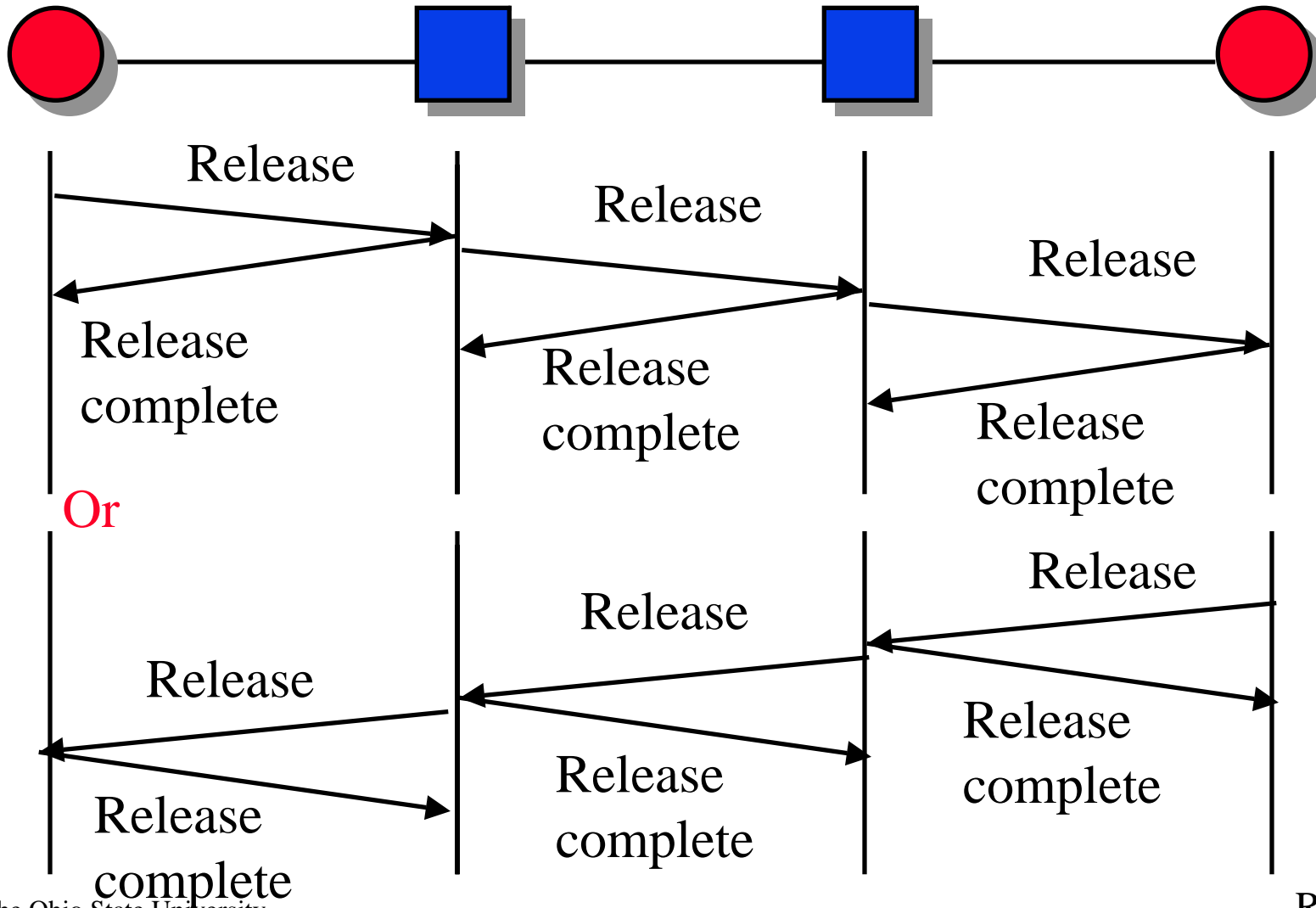

Connection Release (cont)

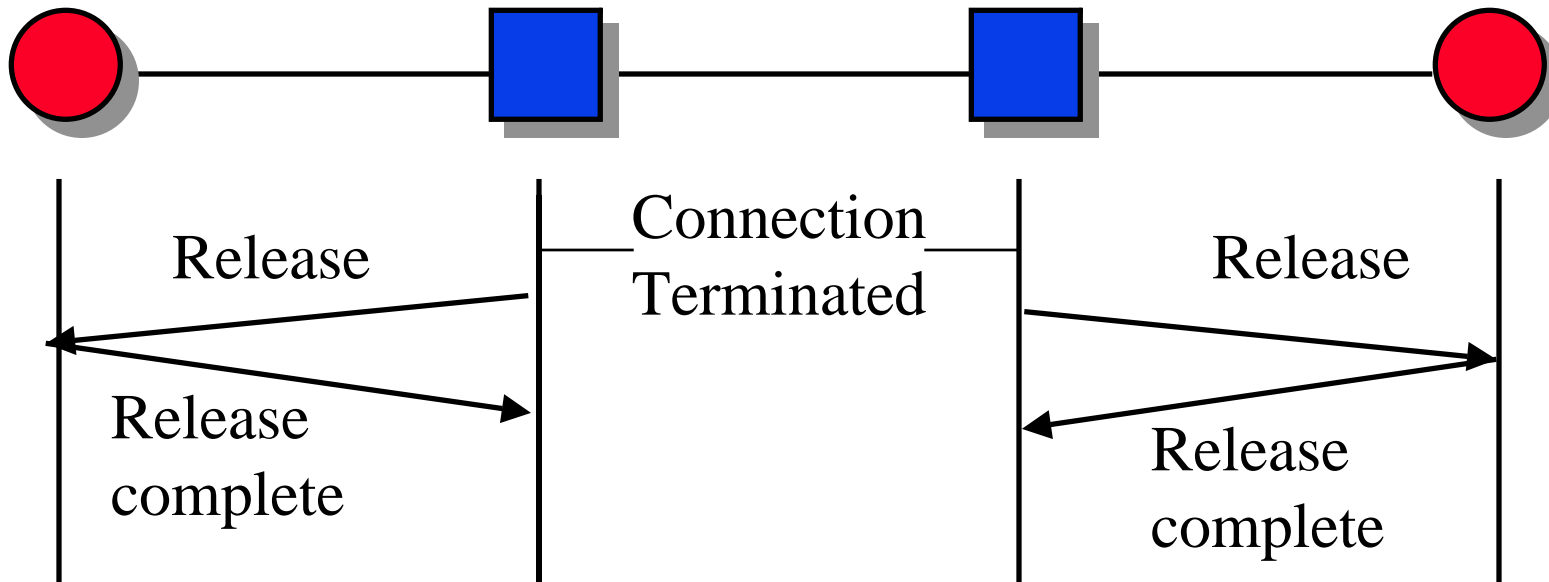

Multipoint Connection Setup



1. Connect to the first party

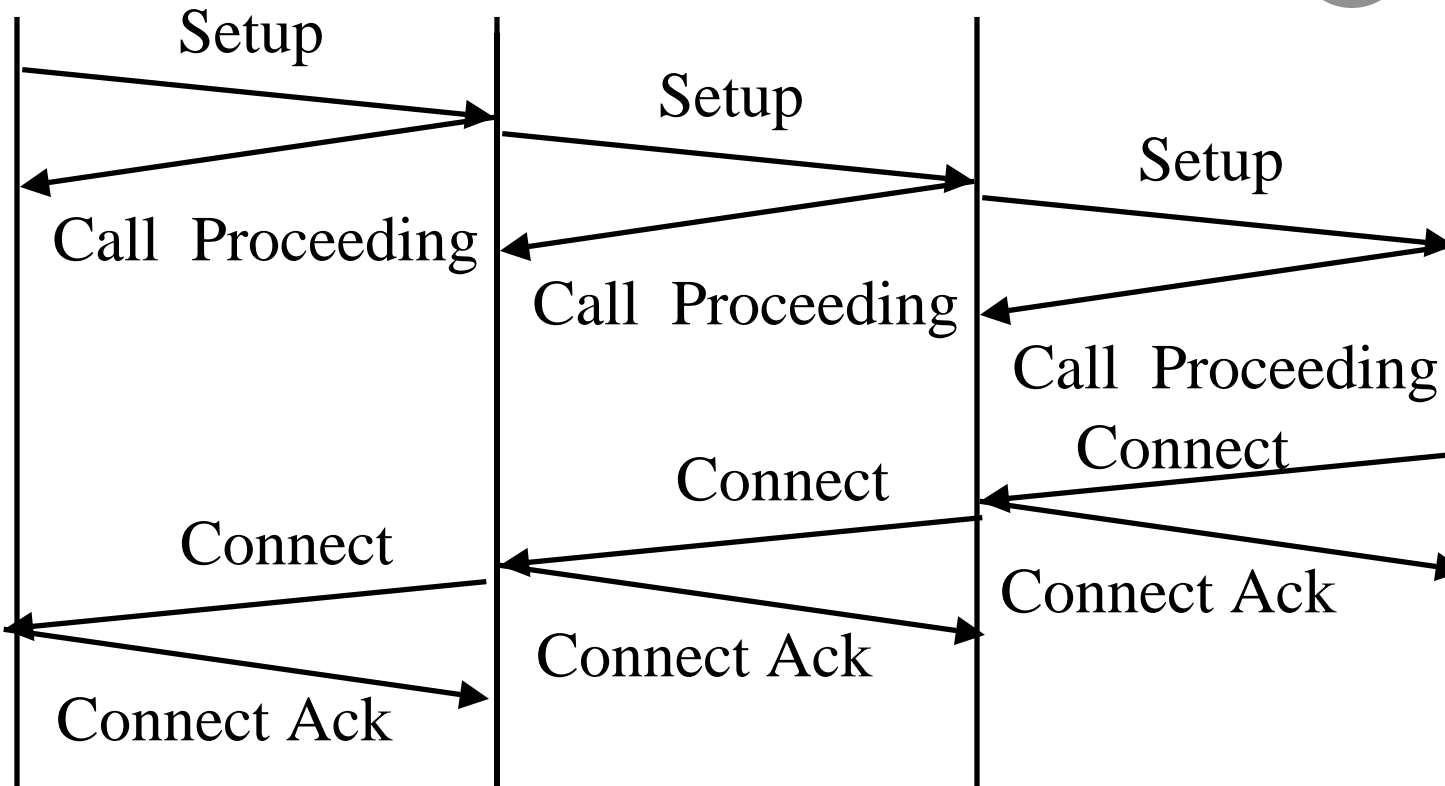

Multipoint Connection Setup (cont)

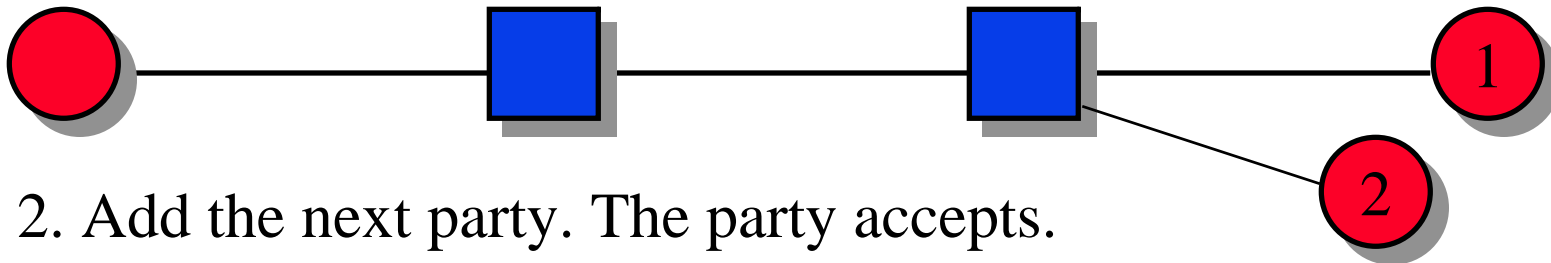

2. Add the next party. The party accepts.

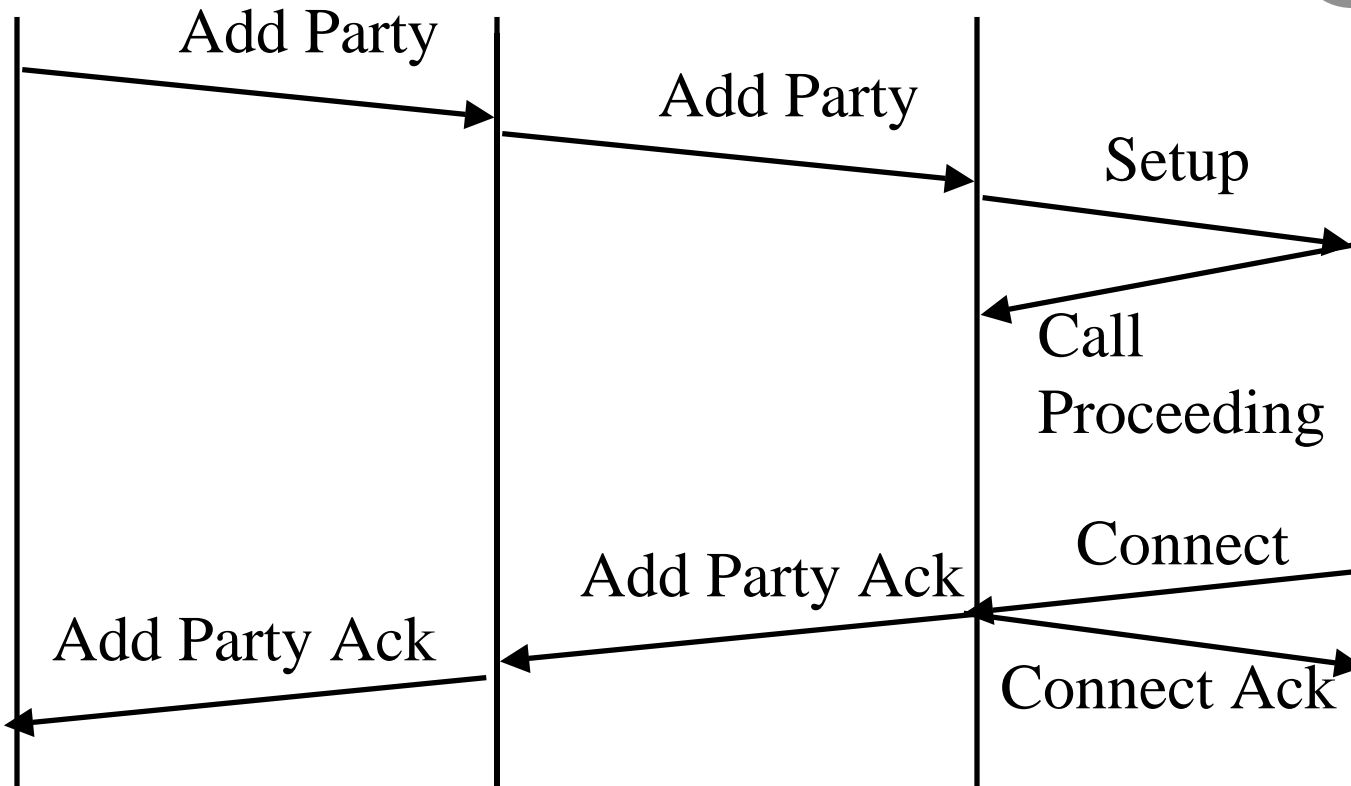

Multipoint Connection Setup (cont)

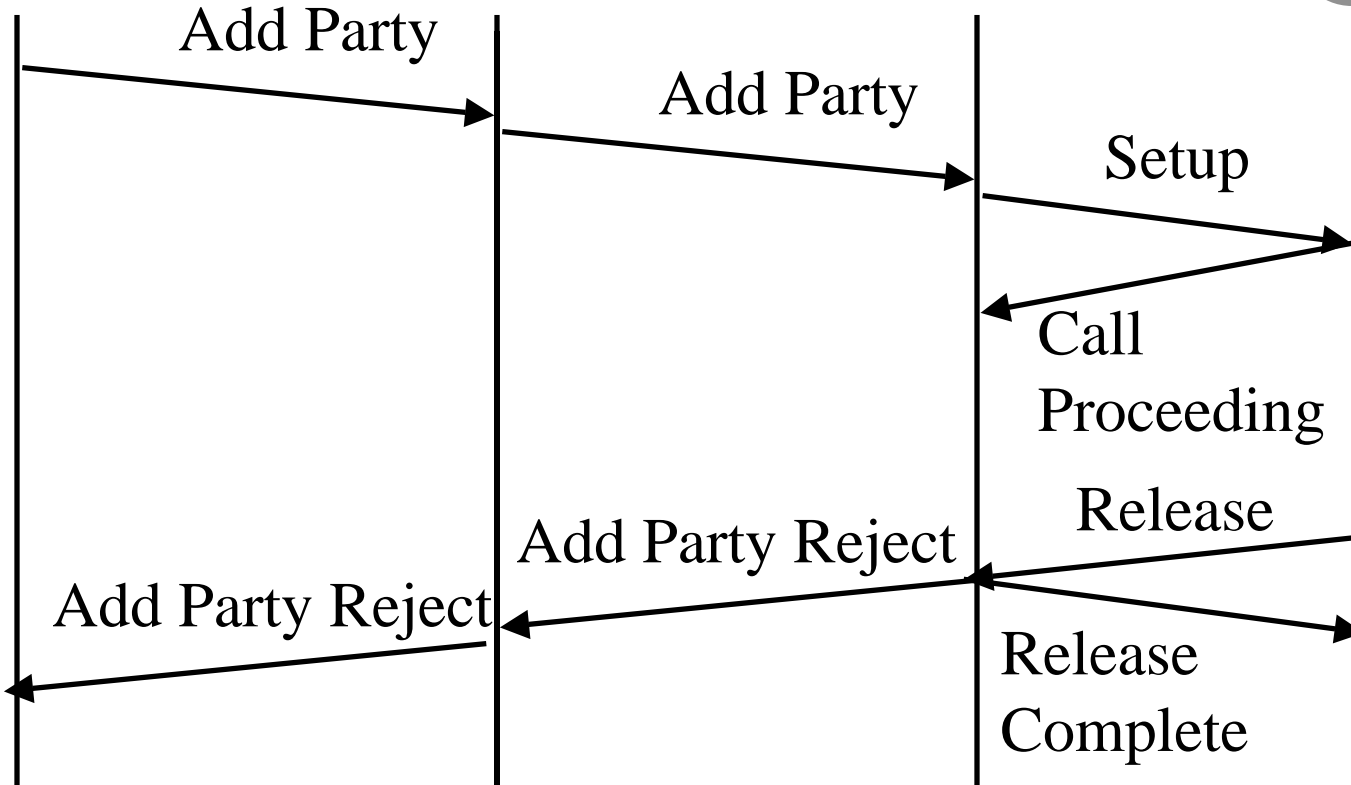

Multipoint Connection Release



1. Root Drops a party

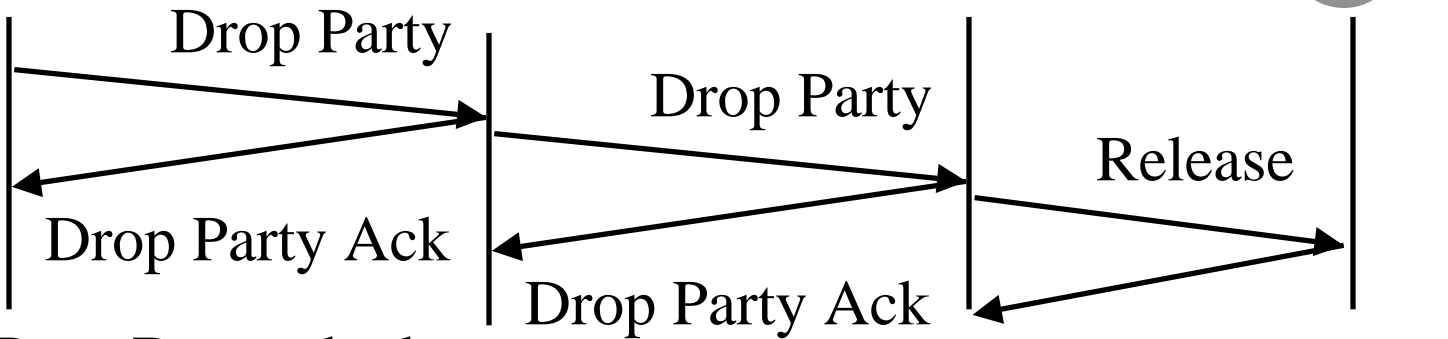

2. Root Drops the last party

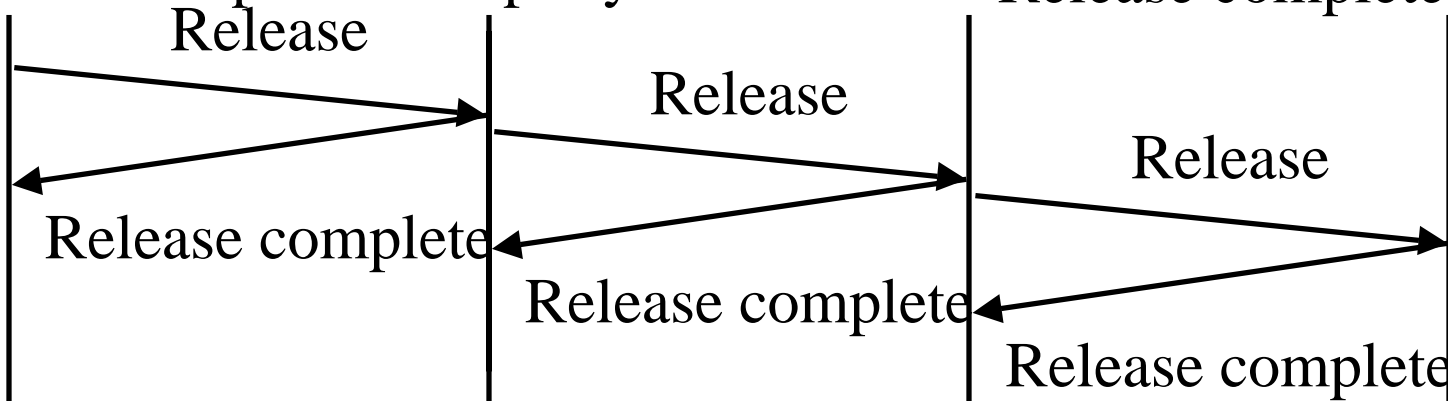

Multipoint Connection Release (cont)



3. A party drops out

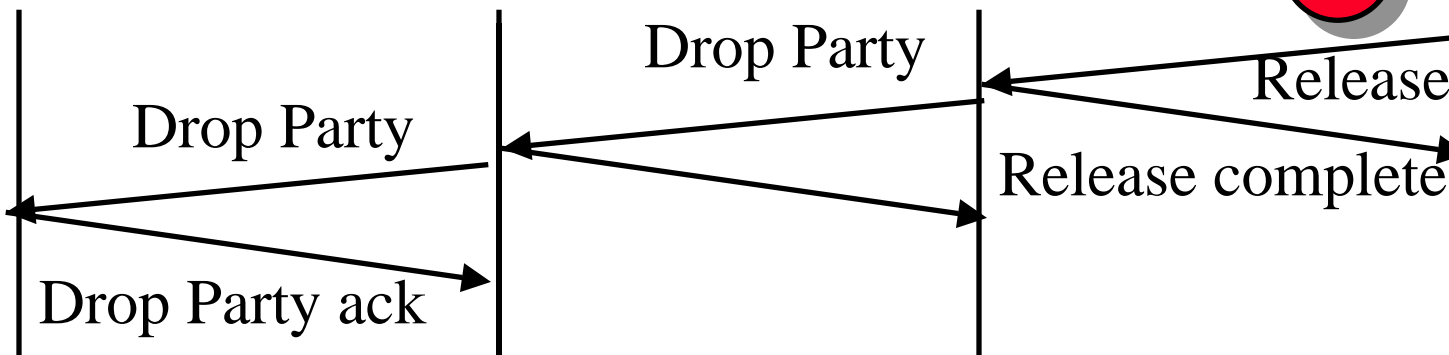

4. Network clears the call

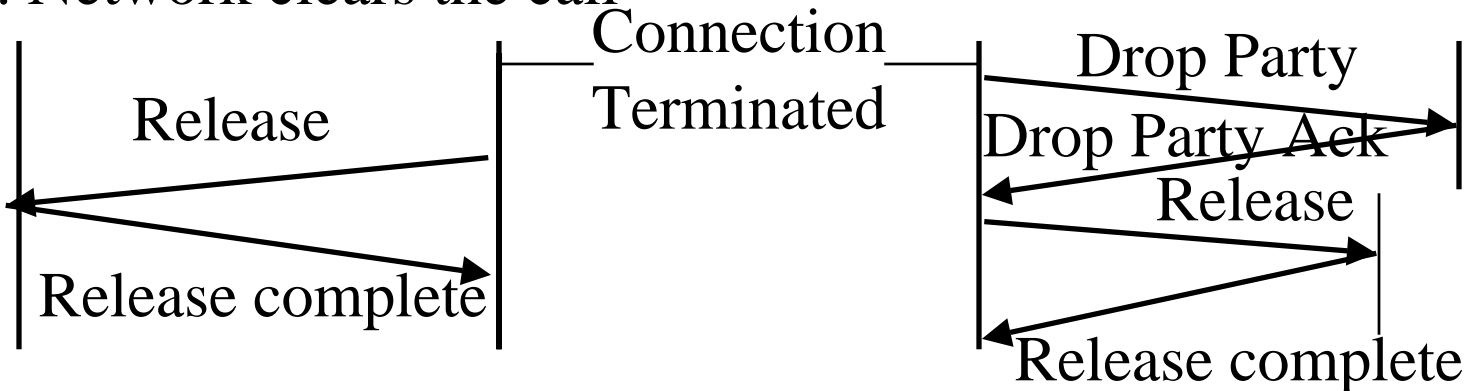

Leaf Initiated Join (LIJ)



1. Root sets up a Network LIJ call

The setup message contains LIJ parameters

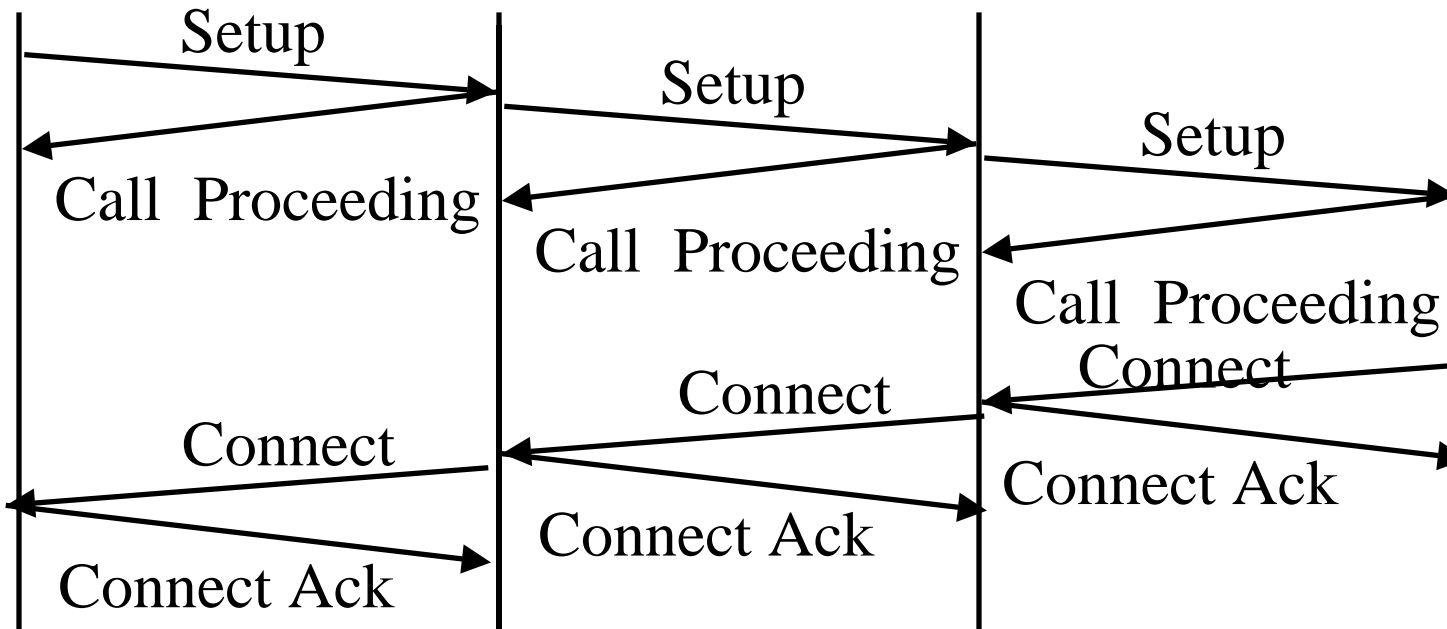

Leaf Join to an Active LIJ Call

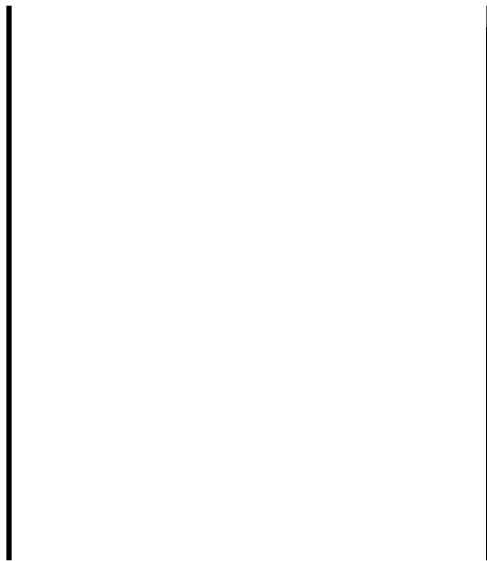

No root notification

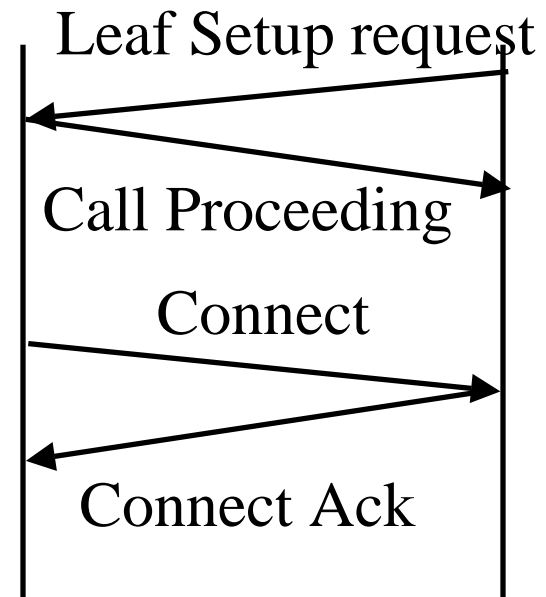

Leaf Join to an Inactive LIJ Call

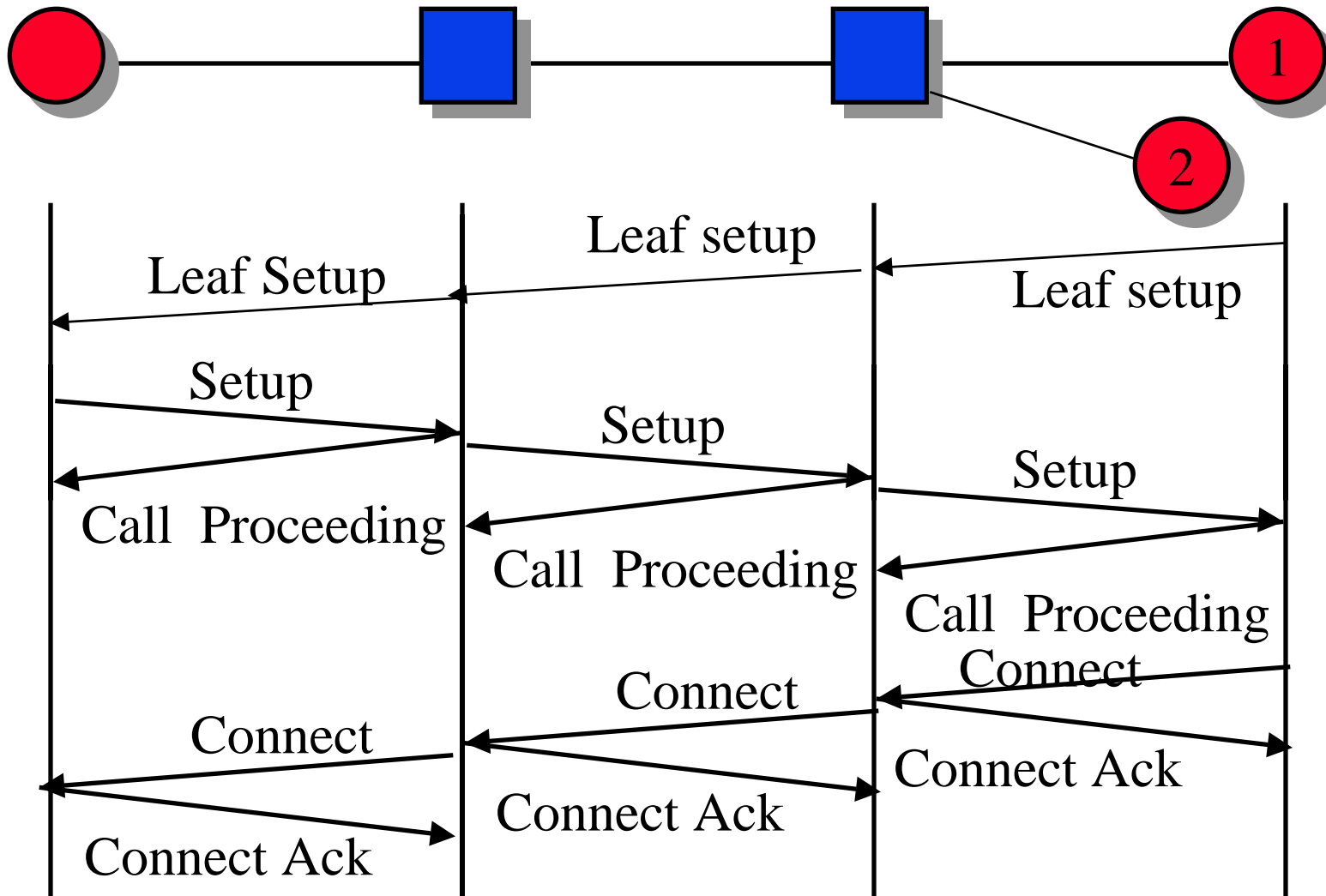

Leaf Join to a non-LIJ Call

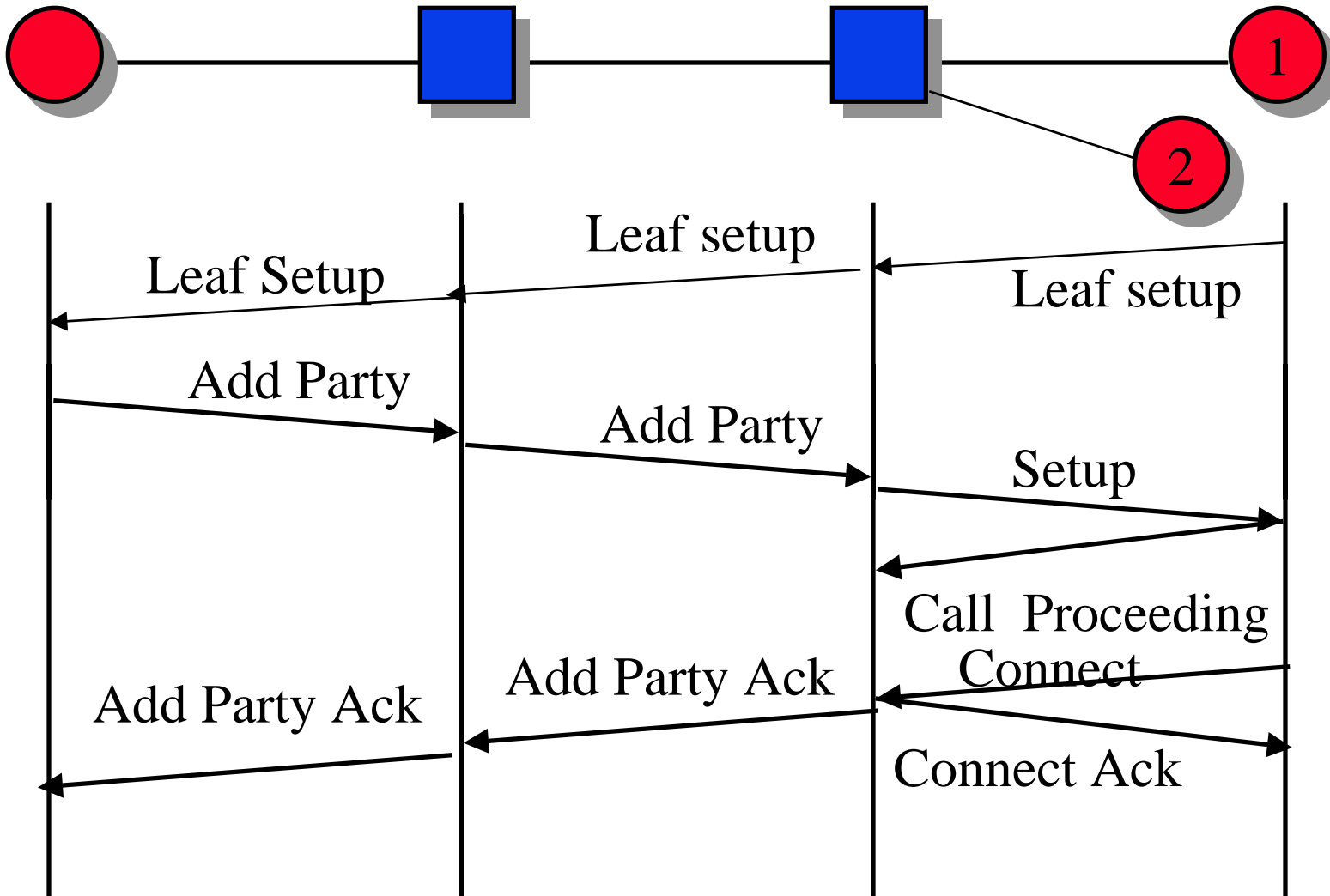

Message Format: Q.2931

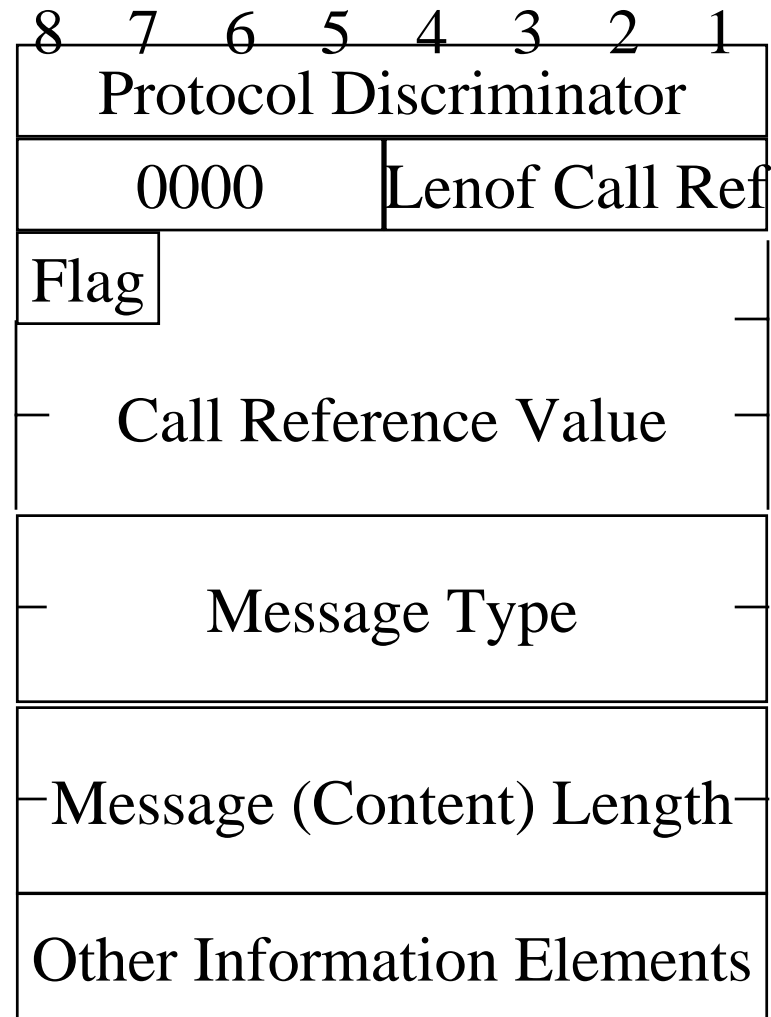

Message Format

- ❑ Protocol Discriminator (1 Byte) = Distinguishes Q.2931 messages from other messages
 - ❑ 08 = Q.931
 - ❑ 09 = Q.2931
- ❑ Call reference (4 bytes) : Identifies call to which this message is related to. One user may have many calls simultaneously.
 - ❑ Flag = 1 Message is from call reference originator
 - ❑ Flag = 0 Message is to call reference originator
- ❑ Message Type (2 Bytes): Many types, e.g., connect, call proceeding, setup, release, etc.
- ❑ Message Length (2 Bytes): Length of contents of this message

Sample Message Types

Bits 876	Bits 54321	Type
000		Call establishment messages
	00010	Call proceeding
	00111	Connect
	01111	Connect Ack
	00101	Setup
	01101	Setup Ack
010		Call Clearing Messages
	01101	Release
	11010	Release complete
011		Information
	10101	Status Inquiry
	11101	Status
111		Reserved for extension

Information Element Formats

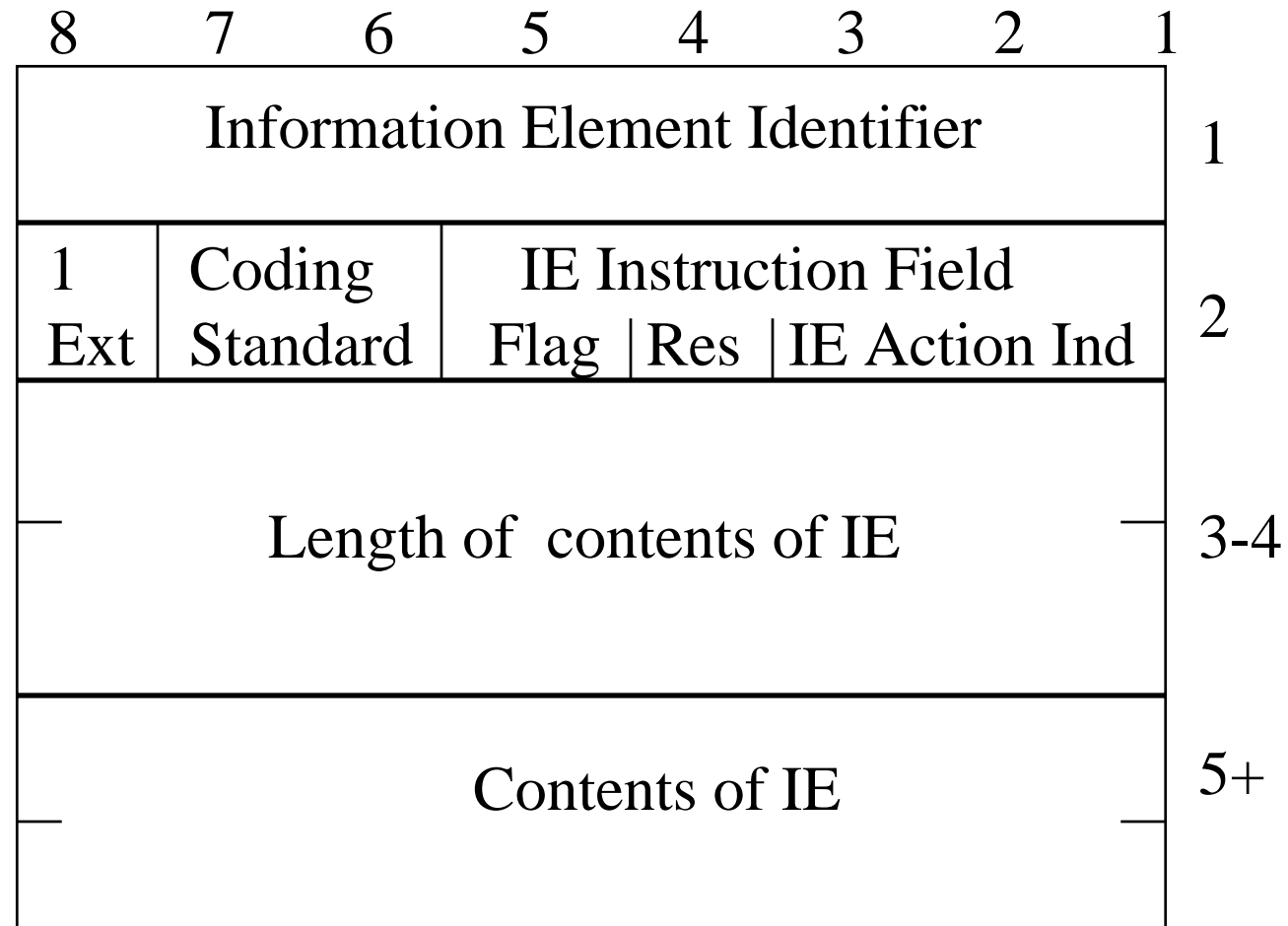

Sample Information Elements

Bits 87654321	Information Element
01110000	Called party number
01110001	Called party subaddress
01111000	Transit network selection
01101100	Calling party number
01101101	Calling party subaddress
01011000	AAL parameter
01011001	ATM Traffic Descriptor
01011010	Connection Identifier
01011100	Quality of Service Parameter
01000010	End-to-end transit delay
01011110	Broadband bearer capability

Information Elements

- ❑ AAL Parameters (4-20B): E.g., max SDU size
- ❑ ATM User Cell rate (12-30B): forward/backward avg/peak cell rates
- ❑ Broadband bearer capability (6-7B): Requested bearer characteristics. CBR or VBR. Susceptible to clipping.
- ❑ Broadband High-Layer Information (4-13B): Used for compatibility checking by the receiving end-point. Transported transparently across the network.
- ❑ Broadband Repeat Indicator (4-5B): How to interpret repeated elements
- ❑ Broadband Low-Layer Information (4-13B): Used for compatibility checking by the receiving end-point, at lower layers, e.g., X.25

- ❑ Call Party Number (Max 25 B)
- ❑ Called Party Subaddress (4-25 B): Used outside the network
- ❑ Calling Party Number (4-26B)
- ❑ Calling party subaddress(4-25B)
- ❑ Cause: Exception reason
- ❑ Call State: current state
- ❑ Connection Identifier (9B): VPCI/VCCI
VPCI = VP Connection ID = VP Id (initially)
Different (later) with VP concentrators
One VP = Multiple lower speed links
Contains additional bits to select among multiple links

- ❑ QoS Parameters (6B)
- ❑ Broadband Sending complete (4-5B): Indicates completion of the called party number. Ignored by ATM Forum.
- ❑ Transit Network Selection (4-8B)
- ❑ Endpoint Reference (4-7B): Identifies individual endpoint of a multipoint connection
- ❑ Endpoint State: State of an endpoint in a point-to-multipoint connection
- ❑ End-to-end Transit Delay
- ❑ Restart Indicator: Identifies class of facility to be restarted

Sample Message Contents

- ❑ Setup message: Call reference, called party address, calling party address, traffic characteristics, quality of service
- ❑ Call proceeding message: Call reference, VPI/VCI
- ❑ Connect Message: Call reference. Indicates call acceptance.
- ❑ Connect Acknowledge: Call reference.

Bandwidth Contract

- User specifies 12 leaky bucket parameters

	Forward	Backward
CLP=0	Peak Cell Rate Sustainable Cell Rate Maximum Burst Size	Peak Cell Rate Sustainable Cell Rate Maximum Burst Size
CLP=0+1	Peak Cell Rate Sustainable Cell Rate Maximum Burst Size	Peak Cell Rate Sustainable Cell Rate Maximum Burst Size

AAL Parameters

- ❑ AAL 1 Parameters
 - ❑ CBR Rate
 - ❑ Clock recovery type
 - ❑ Error correction type
 - ❑ Structured Data Transfer
 - ❑ Partially filled cells
- ❑ AAL 3/4 Parameters
 - ❑ MID Size

AAL Parameters

- ❑ AAL 3/4/5 Parameters
 - ❑ Forward maximum SDU size
 - ❑ Backward maximum SDU size
 - ❑ Mode: message or streaming
 - ❑ Service Specific Convergence Sublayer (SSCS) Type
 - + Null, Assured SSCOP, non-assured SSCOP, or Frame relay

Protocol Stacks

- Signaling AAL (SAAL)
 - Service specific coordination function (SSCF):
Provides interface to Q.2931
 - Service specific connection-oriented protocol (SSCOP):
Error and loss recovery
 - AAL Common Part (AAL CP): Error detection

	Q.2931	TCP/IP	LMI, SNMP
SAAL	SSCF Q.2130	AAL	AAL
	SSCOP Q.2110		
	AAL CP I.363		
ATM I.361			
SONET, DS1, E1, etc. I.432			

UNI 3.1 Features

- ❑ Align with Q.2931
- ❑ Use new version of SSCOP

UNI 4.0 Features

- ❑ Point-to-point and point-to-multipoint calls
- ❑ Leaf initiated join capability
- ❑ Notification of end-to-end connection completion
- ❑ ATM Anycast capability
- ❑ Multiple signalling channels
- ❑ Switched virtual path service
- ❑ Proxy signaling
- ❑ Frame discard capability
- ❑ ABR signaling for point-to-point calls
- ❑ Traffic parameter negotiation

Summary

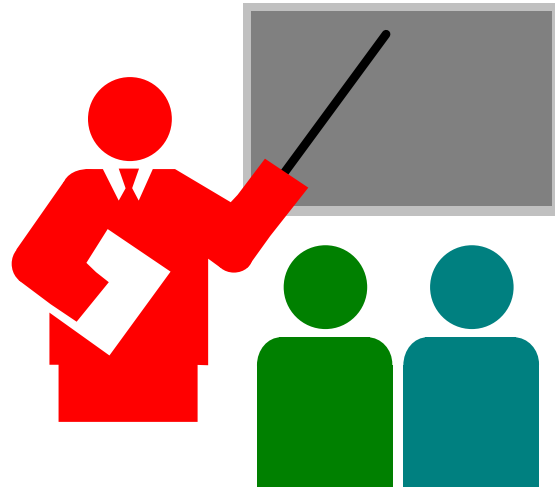

- ❑ NSAP address formats
- ❑ Call setup and release: Point-to-point, point-to-multipoint, Leaf-initiated join
- ❑ Q.2931 Message formats and information elements
- ❑ Traffic contracts

References

- ❑ D. Minoli and G. Dobrowski, “Principles of Signaling for cell relay and frame relay,” Artech House, 1995, 305 pp.
- ❑ RFC 1237, “Guidelines for NSAP allocation in the Internet”
- ❑ ATM94-1018R7, “UNI Signalling 4.0”, October 18, 1995.
<ftp://ftp.atmforum.com/pub/>

B-ISDN Recommendations

- ❑ E.164 Numbering plan for the ISDN era
- ❑ I.113 B-ISDN vocabulary of terms
- ❑ I.150 B-ISDN ATM Functional Characteristics, 1993
- ❑ I.211 B-ISDN Service Aspects, 1993
- ❑ I.311 B-ISDN General Network Aspects, 1993
- ❑ I.321 B-ISDN Protocol Reference Model and Its Application, 1993
- ❑ I.327 B-ISDN Functional Architecture, 1993
- ❑ I.361 B-ISDN ATM Layer Specification, 1993
- ❑ I.362 B-ISDN ATM Adaptation Layer (AAL) Functional Description, 1993

- ❑ I.363 B-ISDN ATM Adaptation Layer (AAL) specification, 1993
- ❑ I.413 B-ISDN User-Network Interface, 1993
- ❑ Q.2110 B-ISDN SAAL Service Specific Connection Oriented Protocol (SSCOP)
- ❑ Q.2130 B-ISDN SAAL Service Specific Coordination function (SSCF)
- ❑ Q.2610 B-ISDN Usage of Cause and Location in B-ISDN user part and DSS2
- ❑ Q.2931 B-ISDN DSS2 User-network Interface (UNI) Layer 3 Specification for Basic call/connection control

- ❑ Q.2951 Stage 3 description for number identification supplementary services using B-ISDN DSS2 Basic Call
- ❑ Q.2961.1 B-ISDN DSS2 Negotiation/Modification: Additional Traffic Parameter Indications
- ❑ Q.2962, Negotiation of traffic and QoS parameters (during call/connection establishment)
- ❑ Q.2963, Renegotiation/modification of traffic and QoS parameters (for already established calls/connections)
- ❑ Q.2964, B-ISDN look-ahead
- ❑ Q.2971 B-ISDN DSS2 UNI Layer 3 Specificatin for Point-to-multipoint Call/connection control
- ❑ Q.298x, Multiconnection calls

Quiz

T F Please check True/False

1. Inband signaling refers to sending control messages on the same physical channels as the data.
2. In associated mode signaling, control follows the same physical path as data.
3. Meta-signaling is used to send nonsignaling messages during connection setup.
4. An ATM NSAP address identifies the network service access point in an ATM end system
5. Complete ATM NSAP address is hardcoded in each end system.
6. UNI 4.0 allows some one tune into a VC without informing the root.

7. Bandwidth contract in UNI consists of 12 forward and backward leaky bucket parameters
8. The AAL used for signaling SAAL and AAL5 have nothing in common
9. SSCOP refers to the policing protocol used in ATM networks.
10. UNI 4.0 allows anycast capability.