

Case Studies Using Patterns

Object-Oriented Design Case Studies with Patterns & C++

Douglas C. Schmidt

Professor
d.schmidt@vanderbilt.edu
www.dre.vanderbilt.edu/~schmidt/

Department of EECS
Vanderbilt University
(615) 343-8197



- The following slides describe several case studies using C++ & patterns to build highly extensible software
- The examples include
 1. Expression Tree
 - e.g., Adapter, Factory, Bridge
 2. System Sort
 - e.g., Facade, Adapter, Iterator, Singleton, Factory Method, Strategy, Bridge
 3. Sort Verifier
 - e.g., Strategy, Factory Method, Facade, Iterator, Singleton



Case Study: Expression Tree Evaluator

- The following inheritance & dynamic binding example constructs *expression trees*
 - Expression trees consist of nodes containing operators & operands
 - * Operators have different *precedence levels*, different *associativities*, & different *arities*, e.g.,
 - Multiplication takes precedence over addition
 - The multiplication operator has two arguments, whereas unary minus operator has only one
 - * Operands are integers, doubles, variables, etc.
 - We'll just handle integers in this example . . .



Expression Tree Diagram

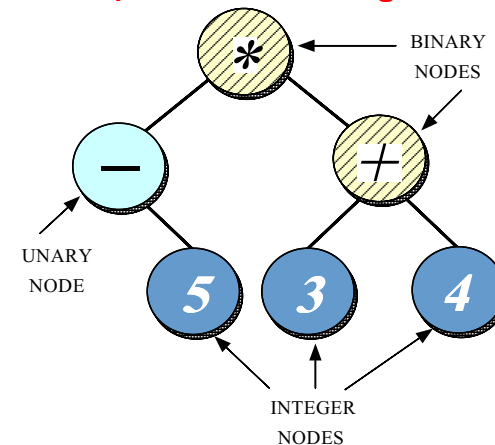

Expression Tree Behavior

- *Expression trees*
 - Trees may be “evaluated” via different traversals
 - * e.g., in-order, post-order, pre-order, level-order
 - The evaluation step may perform various operations, e.g.,
 - * Traverse & print the expression tree
 - * Return the “value” of the expression tree
 - * Generate code
 - * Perform semantic analysis

Memory Layout of Algorithmic Version

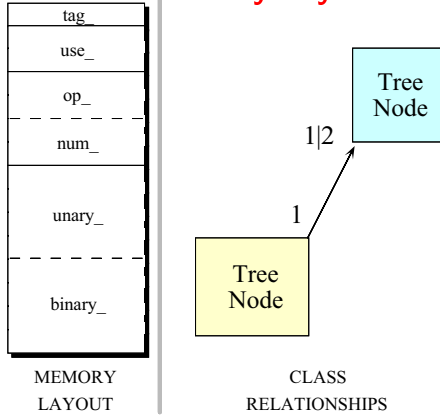

- Here's the memory layout of a struct `Tree_Node` object

Print_Tree Function

- A typical algorithmic implementation use a switch statement & a recursive function to build & evaluate a tree, e.g.,

```
void print_tree (Tree_Node *root) {
    switch (root->tag_) {
        case NUM: printf ("%d", root->num_);
                break;
        case UNARY:
            printf ("%s", root->op_[0]);
            print_tree (root->unary_);
            printf (""); break;
        case BINARY:
            printf ("");
            print_tree (root->binary_.l_);
            printf ("%s", root->op_[0]);
            print_tree (root->binary_.r_);
            printf (""); break;
        default:
            printf ("error, unknown type\n");
    }
}
```

Algorithmic Version

- A typical algorithmic method for implementing expression trees involves using a struct/union to represent data structure, e.g.,

```
typedef struct Tree_Node Tree_Node;
struct Tree_Node {
    enum { NUM, UNARY, BINARY } tag_;
    short use_; /* reference count */
    union {
        char op_[2];
        int num_;
    } o;
    #define num_ o.num_
    #define op_ o.op_
    union {
        Tree_Node *unary_;
        struct { Tree_Node *l_, *r_; } binary_;
    } c;
    #define unary_ c.unary_
    #define binary_ c.binary_
};
```

Limitations with Algorithmic Approach

- Problems or limitations with the typical algorithmic approach include
 - Little or no use of encapsulation
- Incomplete modeling of the application domain, which results in
 1. Tight coupling between nodes & edges in union representation
 2. Complexity being in *algorithms* rather than the *data structures*
 - e.g., switch statements are used to select between various types of nodes in the expression trees
 - Compare with binary search!
 3. Data structures are “passive” & functions do most processing work explicitly

More Limitations with Algorithmic Approach

- The program organization makes it difficult to extend, e.g.,
 - Any small changes will ripple through the entire design & implementation
 - * e.g., see the “ternary” extension below
 - Easy to make mistakes switching on type tags . . .
- Solution wastes space by making worst-case assumptions *wrt* structs & unions
 - This is not essential, but typically occurs
 - Note that this problem becomes worse the bigger the size of the largest item becomes!

OO Alternative

- Contrast previous algorithmic approach with an object-oriented decomposition for the same problem:
 - Start with OO modeling of the “expression tree” application domain, e.g., go back to original picture
 - Discover several classes involved:
 - * class Node: base class that describes expression tree vertices:
 - class Int_Node: used for implicitly converting int to Tree node
 - class Unary_Node: handles unary operators, e.g., -10, +10, !a
 - class Binary_Node: handles binary operators, e.g., a + b, 10 - 30
 - * class Tree: “glue” code that describes expression-tree edges, i.e., relations between Nodes
 - Note, these classes model entities in the application domain
 - * i.e., nodes & edges (vertices & arcs)

Expression Tree Diagram

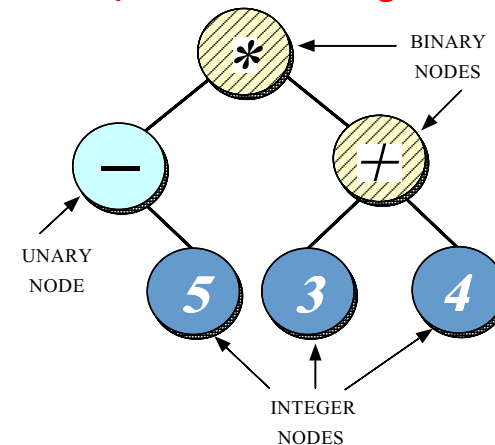

Relationships Between Tree & Node Classes

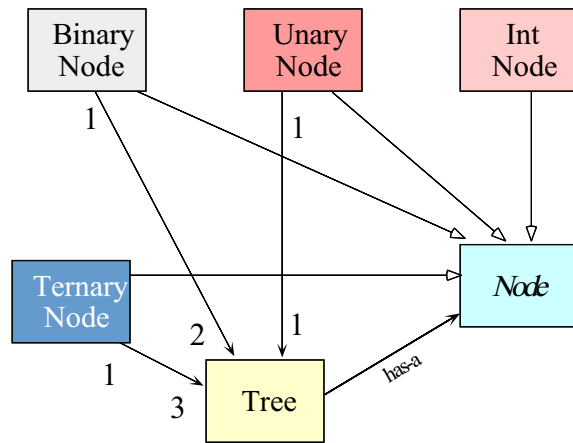

Design Patterns in the Expression Tree Program

- Factory
 - Centralize the assembly of resources necessary to create an object
 - * e.g., decouple Node subclass initialization from use
- Bridge
 - Decouple an abstraction from its implementation so that the two can vary independently
 - * e.g., printing contents of a subtree and managing memory
- Adapter
 - Convert the interface of a class into another interface clients expect
 - * e.g., make Tree conform C++ iostreams

C++ Node Interface

```

class Tree; // Forward declaration

// Describes the Tree vertices
class Node {
friend class Tree;
protected: // Only visible to derived classes
    Node (): use_ (1) {}

    /* pure */ virtual void print (std::ostream &) const = 0;

    // Important to make destructor virtual!
    virtual ~Node ();
private:
    int use_; // Reference counter.
};
  
```

C++ Tree Interface

```

#include "Node.h"
// Bridge class that describes the Tree edges and
// acts as a Factory.
class Tree {
public:
    // Factory operations
    Tree (int);
    Tree (const string &, Tree &);
    Tree (const string &, Tree &, Tree &);
    Tree (const Tree &);
    void operator= (const Tree &);
    ~Tree ();
    void print (std::ostream &) const;
private:
    Node *node_; // pointer to a rooted subtree
  
```

C++ Int_Node Interface

```
#include "Node.h"

class Int_Node : public Node {
public:
    Int_Node (int k);
    virtual void print (std::ostream &stream) const;
private:
    int num_; // operand value.
};
```

C++ Unary_Node Interface

```
#include "Node.h"

class Unary_Node : public Node {
public:
    Unary_Node (const string &op, const Tree &t);
    virtual void print (std::ostream &stream) const;
private:
    string operation_;
    Tree operand_;
};
```

C++ Binary_Node Interface

```
#include "Node.h"

class Binary_Node : public Node {
public:
    Binary_Node (const string &op,
                const Tree &t1,
                const Tree &t2);
    virtual void print (std::ostream &s) const;
private:
    const string operation_;
    Tree left_;
    Tree right_;
};
```

Memory Layout for C++ Version

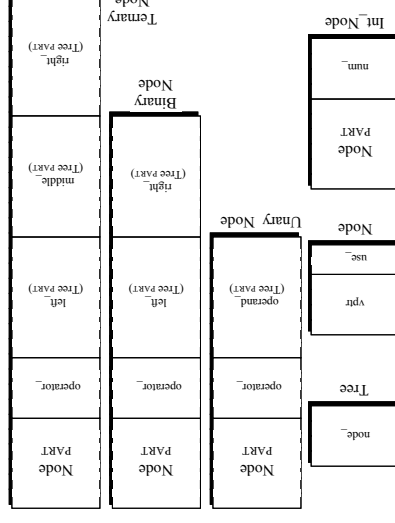

- Memory layouts for different subclasses of Node

C++ Int_Node Implementations

```
#include "Int_Node.h"

Int_Node::Int_Node (int k): num_ (k) { }

void Int_Node::print (std::ostream &stream) const {
    stream << this->num_;
}
}
```

C++ Unary_Node Implementations

```
#include "Unary_Node.h"

Unary_Node::Unary_Node (const string &op, const Tree &t1)
    : operation_ (op), operand_ (t1) { }

void Unary_Node::print (std::ostream &stream) const {
    stream << "(" << this->operation_ <<
        << this->operand_ // recursive call!
        << ")";
}
}
```

C++ Binary_Node Implementation

```
#include "Binary_Node.h"

Binary_Node::Binary_Node (const string &op,
    const Tree &t1,
    const Tree &t2):
    operation_ (op), left_ (t1), right_ (t2) {}

void Binary_Node::print (std::ostream &stream) const {
    stream << "(" << this->left_ // recursive call
        << " " << this->operation_
        << " " << this->right_ // recursive call
        << ")";
}
}
```

Initializing the Node Subclasses

- *Problem*
 - How to ensure the Node subclasses are initialized properly
- *Forces*
 - There are different types of Node subclasses
 - * e.g., take different number & type of arguments
 - We want to centralize initialization in one place because it is likely to change . . .
- *Solution*
 - Use a *Factory* pattern to initialize the Node subclasses

The Factory Pattern

- *Intent*
 - Centralize the assembly of resources necessary to create an object
 - * Decouple object creation from object use by localizing creation knowledge
- This pattern resolves the following forces:
 - Decouple initialization of the Node subclasses from their subsequent use
 - Makes it easier to change or add new Node subclasses later on
 - * e.g., Ternary nodes . . .
- A generalization of the GoF Factory Method pattern

Structure of the Factory Pattern

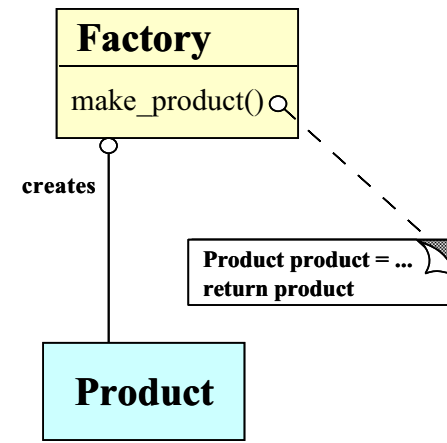

Using the Factory Pattern

- The Factory pattern is used by the Tree class to initialize Node subclasses:

```
Tree::Tree (int num)
: node_ (new Int_Node (num)) {}
```

```
Tree::Tree (const string &op, const Tree &t)
: node_ (new Unary_Node (op, t)) {}
```

```
Tree::Tree (const string &op,
            const Tree &t1,
            const Tree &t2)
: node_ (new Binary_Node (op, t1, t2)) {}
```

Printing Subtrees

- *Problem*
 - How do we print subtrees without revealing their types?
- *Forces*
 - The Node subclass should be hidden within the Tree instances
 - We don't want to become dependent on the use of Nodes, inheritance, & dynamic binding, etc.
 - We don't want to expose dynamic memory management details to application developers
- *Solution*
 - Use the *Bridge* pattern to shield the use of inheritance & dynamic binding

The Bridge Pattern

- *Intent*
 - Decouple an abstraction from its implementation so that the two can vary independently
- This pattern resolves the following forces that arise when building extensible software with C++
 1. *How to provide a stable, uniform interface that is both closed & open, i.e.,*
 - interface is *closed* to prevent direct code changes
 - Implementation is *open* to allow extensibility
 2. *How to manage dynamic memory more transparently & robustly*
 3. *How to simplify the implementation of operator<<*

Structure of the Bridge Pattern

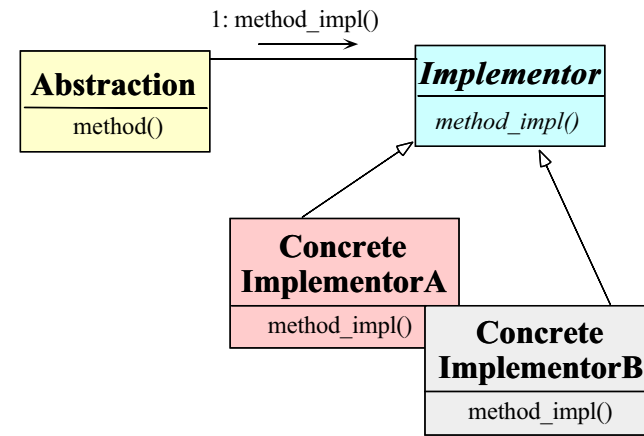

Using the Bridge Pattern

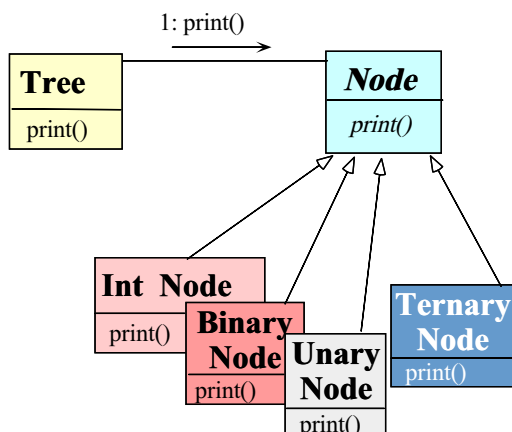

Illustrating the Bridge Pattern in C++

- The Bridge pattern is used for printing expression trees:

```

void Tree::print (std::ostream &os) const {
    this->node_>print (os);
}
      
```
- Note how this pattern decouples the Tree interface for printing from the Node subclass implementation
 - *i.e.*, the Tree interface is *fixed*, whereas the Node implementation varies
 - However, clients need not be concerned about the variation . . .

Integrating with C++ I/O Streams

- *Problem*
 - Our Tree interface uses a `print` method, but most C++ programmers expect to use I/O Streams
- *Forces*
 - Want to integrate our existing C++ Tree class into the I/O Stream paradigm without modifying our class or C++ I/O
- *Solution*
 - Use the *Adapter* pattern to integrate Tree with I/O Streams

The Adapter Pattern

- *Intent*
 - Convert the interface of a class into another interface client expects
 - * Adapter lets classes work together that couldn't otherwise because of incompatible interfaces
- This pattern resolves the following force:
 1. How to transparently integrate the Tree with the C++ `std::ostream` operators

Structure of the Adapter Pattern

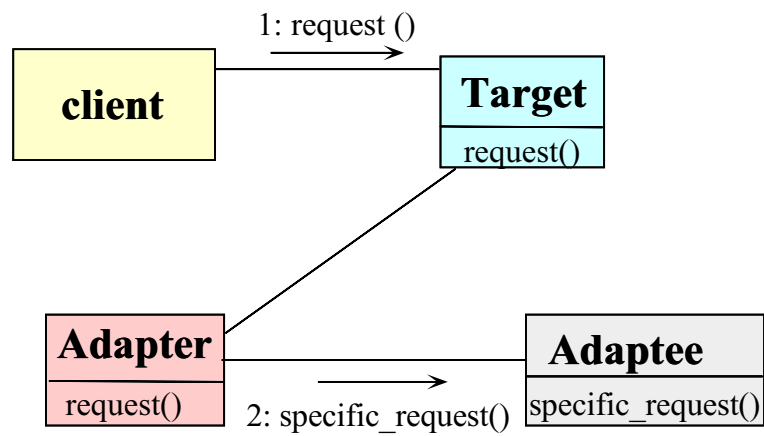

Using the Adapter Pattern

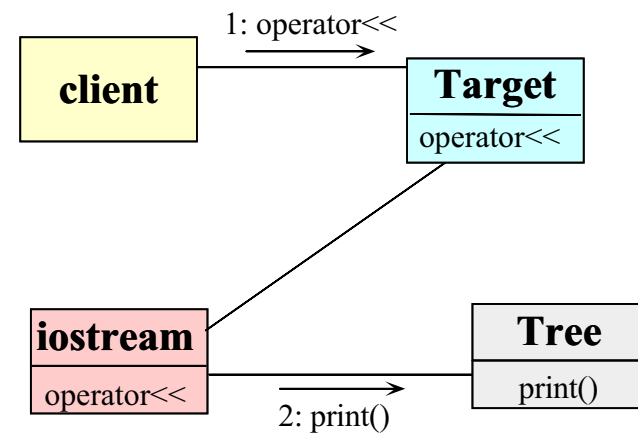

Using the Adapter Pattern

- The Adapter pattern is used to integrate with C++ I/O Streams

```
std::ostream &operator<< (std::ostream &s, const Tree &tree) {
    tree.print (s);
    // This triggers Node * virtual call via
    // tree.node_>print (s), which is
    // implemented as the following:
    // (*tree.node_>vptr[I]) (tree.node_, s);
    return s;
}
```

- Note how the C++ code shown above uses I/O streams to “adapt” the Tree interface . . .

C++ Tree Implementation

- Reference counting via the “counted body” idiom

```
Tree::Tree (const Tree &t): node_ (t.node_) {
    ++this->node_>use_; // Sharing, ref-counting.
}

void Tree::operator= (const Tree &t) {
    if (this == &t) return;
    // order important here!
    ++t.node_>use_;
    --this->node_>use_;
    if (this->node_>use_ == 0)
        delete this->node_;
    this->node_ = t.node_;
}
```

C++ Tree Implementation (cont'd)

```
Tree::~Tree () {
    // Ref-counting, garbage collection
    --this->node_>use_;
    if (this->node_>use_<= 0)
        delete this->node_;
}
```

C++ Main Program

```
#include <istream>:ostream.h>
#include "Tree.h"

int main (int, char *[]) {
    const Tree t1 = Tree ("*", Tree ("-", 5),
                        Tree ("+", 3, 4));
    cout << t1 << endl; // prints ((-5) * (3 + 4))
    const Tree t2 = Tree ("*", t1, t1);

    // prints ((-5) * (3 + 4)) * ((-5) * (3 + 4)).
    cout << t2 << endl;

    return 0;
    // Destructors of t1 \& t2 recursively
    // delete entire tree when leaving scope.
}
```

Expression Tree Diagram 1

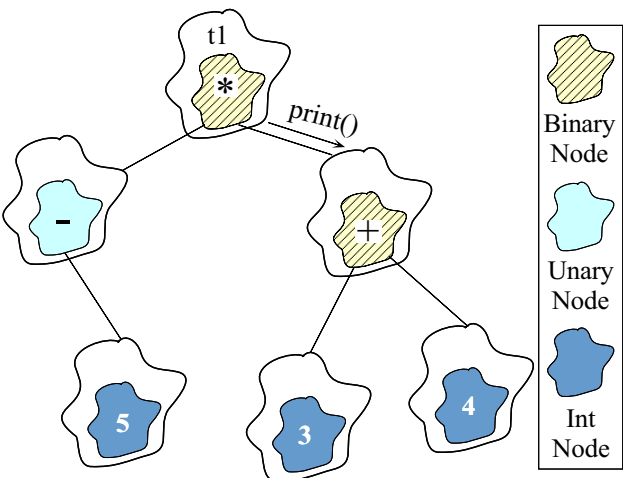

- Expression tree for $t1 = ((-5) * (3 + 4))$



Adding Ternary_Nodes

- Extending the existing program to support ternary nodes is straightforward

– *i.e.*, just derive new class Ternary_Node to handle ternary operators, *e.g.*, $a == b ? c : d$, etc.

```
#include "Node.h"
class Ternary_Node : public Node {
public:
    Ternary_Node (const string &, const Tree &,
                 const Tree &, const Tree &);
    virtual void print (std::ostream &) const;
private:
    const string operation_;
    Tree left_, middle_, right_; };
```



Expression Tree Diagram 2

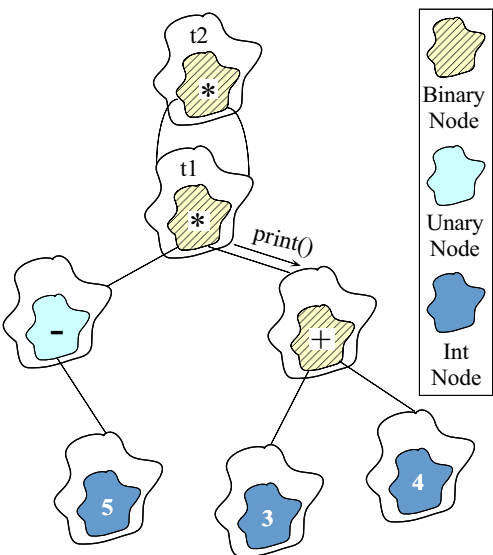

- Expression tree for $t2 = (t1 * t1)$



C++ Ternary_Node Implementation

```
#include "Ternary_Node.h"
Ternary_Node::Ternary_Node (const string &op,
                           const Tree &a,
                           const Tree &b,
                           const Tree &c)
    : operation_(op), left_(a), middle_(b),
      right_(c) {}

void Ternary_Node::print (std::ostream &stream) const {
    stream << this->operation_ << "("
    << this->left_ // recursive call
    << ", " << this->middle_ // recursive call
    << ", " << this->right_ // recursive call
    << ")";
}
```



C++ Ternary_Node Implementation (cont'd)

```
// Modified class Tree Factory
class Tree {
// add 1 class constructor
public:
    Tree (const string &, const Tree &,
          const Tree &, const Tree &)
    : node_ (new Ternary_Node (op, l, m, r)) {}
// Same as before . . .
```

Differences from Algorithmic Implementation

- On the other hand, modifying the original algorithmic approach requires changing (1) the original data structures, e.g.,

```
struct Tree_Node {
enum {
    NUM, UNARY, BINARY, TERNARY
} tag_; // same as before
union {
    // same as before. But, add this:
    struct {
        Tree_Node *l_, *m_, *r_;
    } ternary_;
} c;
#define ternary_ c.ternary_
};
```

Differences from Algorithmic Implementation (cont'd)

```
void print_tree (Tree_Node *root) {
// same as before
case TERNARY: // must be TERNARY.
    printf ("%i");
    print_tree (root->ternary_.l_);
    printf ("%c", root->op_[0]);
    print_tree (root->ternary_.m_);
    printf ("%c", root->op_[1]);
    print_tree (root->ternary_.r_);
    printf ("%i"); break;
// same as before
}
```

Summary of Expression Tree Example

- OO version represents a more complete modeling of the application domain
 - e.g., splits data structures into modules that correspond to “objects” & relations in expression trees
- Use of C++ language features simplifies the design and facilitates extensibility
 - e.g., implementation follows directly from design
- Use of patterns helps to motivate, justify, & generalize design choices

Potential Problems with OO Design

- Solution is very “data structure rich”
 - e.g., requires configuration management to handle many headers & .cpp files!
- May be somewhat less efficient than original algorithmic approach
 - e.g., due to virtual function overhead
- In general, however, virtual functions may be no less inefficient than large switch statements or if/else chains . . .
- As a rule, be careful of micro vs. macro optimizations
 - i.e., always profile your code!

Case Study: System Sort

- Develop a general-purpose system sort
 - It sorts lines of text from standard input and writes the result to standard output
 - e.g., the UNIX system sort
- In the following, we'll examine the primary forces that shape the design of this application
- For each force, we'll examine patterns that resolve it

External Behavior of System Sort

- A “line” is a sequence of characters terminated by a newline
- Default ordering is lexicographic by bytes in machine collating sequence (e.g., ASCII)
- The ordering is affected globally by the following options:
 - Ignore case (`-f`)
 - Sort numerically (`-n`)
 - Sort in reverse (`-r`)
 - Begin sorting at a specified field (`-k`)
 - Begin sorting at a specified column (`-c`)
- Your program need not sort files larger than main memory

High-level Forces

- Solution should be both time & space efficient
 - e.g., must use appropriate algorithms and data structures
 - Efficient I/O & memory management are particularly important
 - Our solution uses minimal dynamic binding (to avoid unnecessary overhead)
- Solution should leverage reusable components
 - e.g., `istd::ostreams`, `Array` & `Stack` classes, etc.
- Solution should yield reusable components
 - e.g., efficient input classes, generic sort routines, etc.

Top-level Algorithmic View of the Solution

- Note the use of existing C++ mechanisms like I/O streams

```
// Reusable function:
// template <typename ARRAY> void sort (ARRAY &a);

int main (int argc, char *argv[])
{
    parse_args (argc, argv);
    Input input;

    cin >> input;
    sort (input);
    cout << input;
}
```

Top-level Algorithmic View of the Solution (cont'd)

- Avoid the *grand mistake* of using top-level algorithmic view to structure the design . . .
 - Structure the design to resolve the forces!
 - Don't focus on algorithms or data, but instead look at the problem, its participants, & their interactions!

General OOD Solution Approach

- Identify the classes in the application/problem space & solution space
 - e.g., stack, array, input class, options, access table, sorts, etc.
- Recognize & apply common design patterns
 - e.g., Singleton, Factory, Adapter, Iterator
- Implement a framework to coordinate components
 - e.g., use C++ classes & parameterized types

C++ Class Model

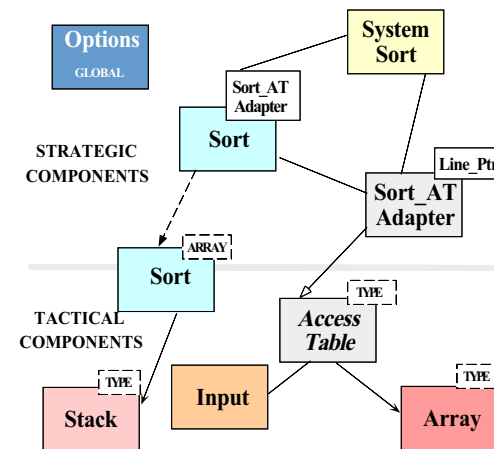

C++ Class Components

- *Tactical components*
 - Stack
 - * Used by non-recursive quick sort
 - Array
 - * Stores/sorts pointers to lines & fields
 - Access_Table
 - * Used to store input
 - Input
 - * Efficiently reads arbitrary sized input using only 1 dynamic allocation & 1 copy

C++ Class Components

- *Strategic components*
 - System_Sort
 - * Facade that integrates everything . . .
 - Sort_AT_Adapter
 - * Integrates Array & Access_Table
 - Options
 - * Manages globally visible options
 - Sort
 - * e.g., both quicksort & insertion sort

Detailed Format for Solution

- Note the separation of concerns



```
// Prototypes
template <typename ARRAY> void sort (ARRAY &a);
void operator>> (std::istream &, Sort_AT_Adapter &);
void operator<< (std::ostream &, const Sort_AT_Adapter &);

int main (int argc, char *argv[])
{
    Options::instance ()->parse_args (argc, argv);
    cin >> System_Sort::instance ()->access_table ();
    sort (System_Sort::instance ()->access_table ());
    cout << System_Sort::instance ()->access_table ();
}
```

Reading Input Efficiently

- *Problem*
 - The input to the system sort can be arbitrarily large (e.g., up to 1/2 size of main memory)
- *Forces*
 - To improve performance solution must minimize:
 1. Data copying & data manipulation
 2. Dynamic memory allocation
- *Solution*
 - Create an Input class that reads arbitrary input efficiently

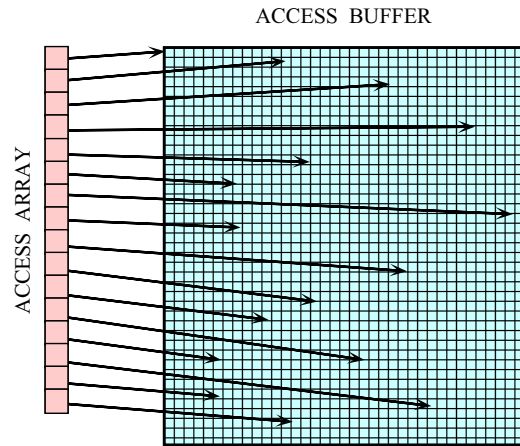
Access Table Format



The Input Class

- Efficiently reads arbitrary-sized input using only 1 dynamic allocation

```
class Input {
public:
    // Reads from <input> up to <terminator>, replacing <search>
    // with <replace>. Returns dynamically allocated buffer.
    char *read (std::istream &input, int terminator = EOF,
               int search = '\n', int replace = '\0');
    // Number of bytes replaced.
    size_t replaced () const;
    // Size of buffer.
    size_t size () const;
private:
    // Recursive helper method.
    char *recursive_read ();
    // . . .
};
```

The Input Class (cont'd)

```
char *Input::read (std::istream &i, int t, int s, int r)
{
    // Initialize all the data members...
    return recursive_read ();
}

char *Input::recursive_read () {
    char buffer[BUFSIZ];
    // 1. Read input one character at a time, performing
    // search/replace until EOF is reached or buffer
    // is full.
    // 1.a If buffer is full, invoke recursive_read()
    // recursively.
    // 1.b If EOF is reached, dynamically allocate chunk
    // large enough to hold entire input
    // 2. On way out of recursion, copy buffer into chunk
}
```

Design Patterns in the System Sort

- Facade
 - Provide a unified interface to a set of interfaces in a subsystem
 - Facade defines a higher-level interface that makes the subsystem easier to use
 - e.g., sort() function provides a facade for the complex internal details of efficient sorting
- Adapter
 - Convert the interface of a class into another interface clients expect
 - Adapter lets classes work together that couldn't otherwise because of incompatible interfaces
 - e.g., make Access_Table conform to interfaces expected by sort & istd::ostreams

Design Patterns in System Sort (cont'd)

- Factory
 - Centralize assembly of resources needed to create objects
 - e.g., decouple initialization of Line_Ptrs used by Access_Table from their subsequent use
- Bridge
 - Decouple an abstraction from its implementation so that the two can vary independently
 - e.g., comparing two lines to determine ordering
- Strategy
 - Define a family of algorithms, encapsulate each one, & make them interchangeable
 - e.g., allow flexible pivot selection

Design Patterns in System Sort (cont'd)

- Singleton
 - Ensure a class has only one instance, & provide a global point of access to it
 - e.g., provides a single point of access for the system sort facade & for program options
- Iterator
 - Provide a way to access the elements of an aggregate object sequentially without exposing its underlying representation
 - e.g., provides a way to print out the sorted lines without exposing representation or initialization

Sort Algorithm

- For efficiency, two types of sorting algorithms are used:
 1. *Quicksort*
 - Highly time & space efficient sorting arbitrary data
 - $O(n \log n)$ average-case time complexity
 - $O(n^2)$ worst-case time complexity
 - $O(\log n)$ space complexity
 - Optimizations are used to avoid worst-case behavior
 2. *Insertion sort*
 - Highly time & space efficient for sorting “almost ordered” data
 - $O(n^2)$ average- & worst-case time complexity
 - $O(1)$ space complexity

Quicksort Optimizations

1. *Non-recursive*
 - Uses an explicit stack to reduce function call overhead
2. *Median of 3 pivot selection*
 - Reduces probability of worse-case time complexity
3. *Guaranteed (log n) space complexity*
 - Always “pushes” larger partition
4. *Insertion sort for small partitions*
 - Insertion sort runs fast on almost sorted data

Selecting a Pivot Value

- *Problem*
 - There are various algorithms for selecting a pivot value
 - * e.g., randomization, median of three, etc.
- *Forces*
 - Different input may sort more efficiently using different pivot selection algorithms
- *Solution*
 - Use the *Strategy* pattern to select the pivot selection algorithm

The Strategy Pattern

- *Intent*
 - Define a family of algorithms, encapsulate each one, & make them interchangeable
 - * Strategy lets the algorithm vary independently from clients that use it
- This pattern resolves the following forces
 1. *How to extend the policies for selecting a pivot value without modifying the main quicksort algorithm*
 2. *Provide a one size fits all interface without forcing a one size fits all implementation*

Structure of the Strategy Pattern

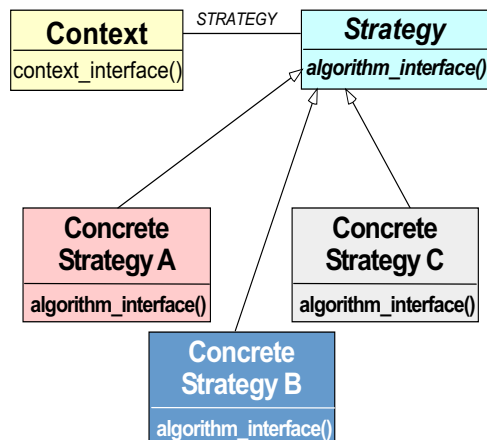

Using the Strategy Pattern

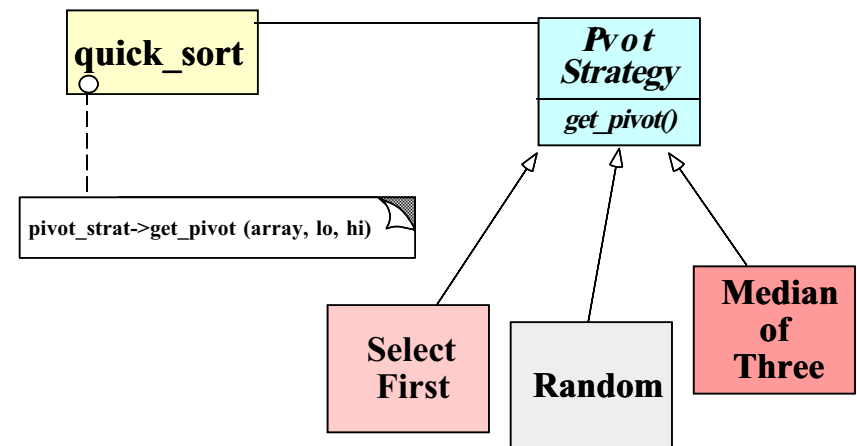

Implementing the Strategy Pattern

- ARRAY is the particular “context”

```
template <typename ARRAY>
void sort (ARRAY &array) {
    Pivot_Strategy<ARRAY> *pivot_strat =
        Pivot_Factory<ARRAY>::make_pivot
            (Options::instance ()->pivot_strat ());
    std::auto_ptr <Pivot_Strategy<ARRAY> >
        holder (pivot_strat);
    // Ensure exception safety.
    ARRAY temp = array;
    quick_sort (temp, pivot_strat);
    // Destructor of <holder> deletes <pivot_strat>.
    array = temp;
}
```

Implementing the Strategy Pattern

```
template <typename ARRAY, class PIVOT_STRAT>
quick_sort (ARRAY &array,
            PIVOT_STRAT *pivot_strat) {
    for (;;) {
        typename ARRAY::TYPE pivot =
            // Note 'lo' & 'hi' should be passed by reference
            // so get_pivot() can reorder the values & update
            // 'lo' & 'hi' accordingly...
            pivot_strat->get_pivot (array, lo, hi);
        // Partition array[lo, hi] relative to pivot . . .
    }
}
```

Fixed-size Stack

- Defines a fixed size stack for use with non-recursive quicksort

```
template <typename T, size_t SIZE>
class Fixed_Stack
{
public:
    bool push (const T &new_item);
    bool pop (T &item);
    bool is_empty ();
    // . . .
private:
    T stack_[SIZE];
    size_t top_;
};
```

Devising a Simple Sort Interface

- *Problem*
 - Although the implementation of the sort function is complex, the interface should be simple to use
- *Key forces*
 - Complex interface are hard to use, error prone, and discourage extensibility & reuse
 - Conceptually, sorting only makes a few assumptions about the “array” it sorts
 - * e.g., supports operator [] methods, size, & trait TYPE
 - We don’t want to arbitrarily limit types of arrays we can sort
- *Solution*
 - Use the *Facade* & *Adapter* patterns to simplify the sort program

Facade Pattern

- *Intent*
 - Provide a unified interface to a set of interfaces in a subsystem
 - * Facade defines a higher-level interface that makes the subsystem easier to use
- This pattern resolves the following forces:
 1. Simplifies the sort interface
 - e.g., only need to support operator [] & size methods, & element TYPE
 2. Allows the implementation to be efficient and arbitrarily complex without affecting clients

Structure of the Facade Pattern

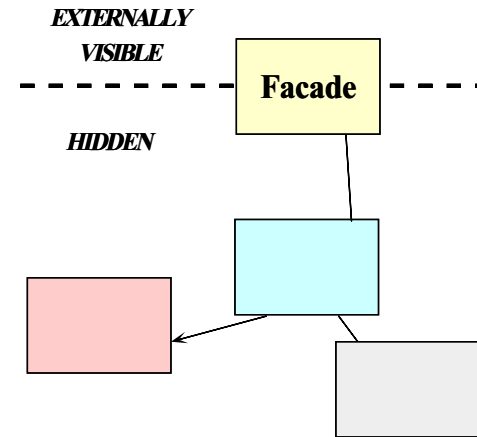

Using the Facade Pattern

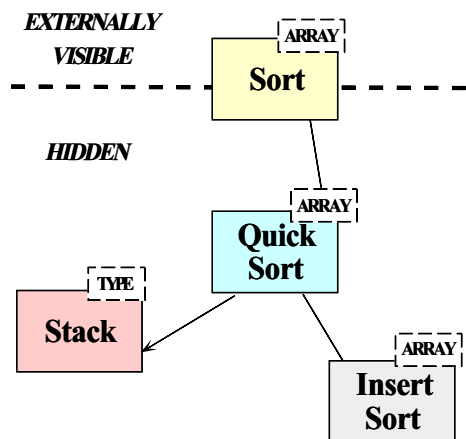

Centralizing Option Processing

- *Problem*
 - Command-line options must be global to many parts of the sort program
- *Key forces*
 - Unrestricted use of global variables increases system coupling & can violate encapsulation
 - Initialization of static objects in C++ can be problematic
- *Solution*
 - Use the *Singleton* pattern to centralize option processing

Singleton Pattern

- *Intent*
 - Ensure a class has only one instance, & provide a global point of access to it
- This pattern resolves the following forces:
 1. Localizes the creation & use of “global” variables to well-defined objects
 2. Preserves encapsulation
 3. Ensures initialization is done after program has started & only on first use
 4. Allow transparent subclassing of Singleton implementation

Structure of the Singleton Pattern

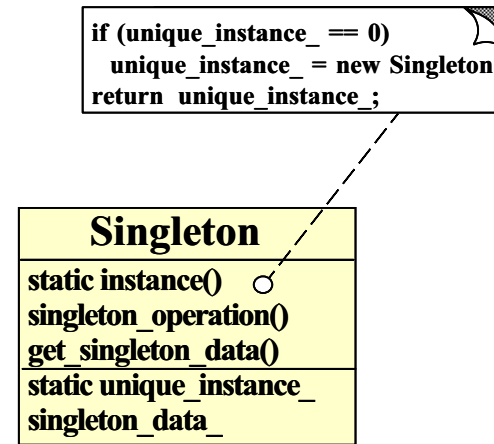

Using the Singleton Pattern

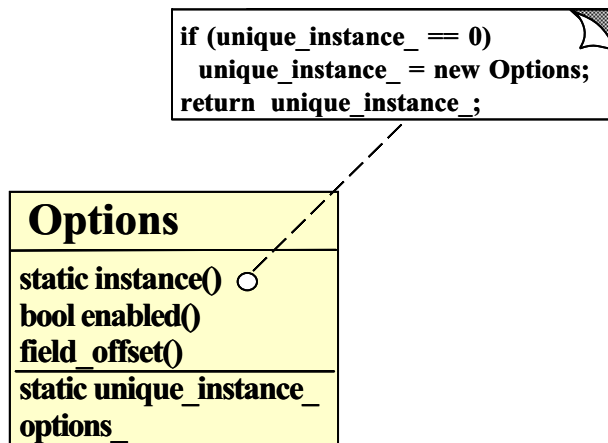

Options Class

- This manages globally visible options

```

class Options
{
public:
    static Options *instance ();
    bool parse_args (int argc, char *argv []);

    // These options are stored in octal order
    // so that we can use them as bitmasks!
    enum Option { FOLD = 01, NUMERIC = 02,
                 REVERSE = 04, NORMAL = 010 };
    enum Pivot_Strategy { MEDIAN, RANDOM, FIRST };
  
```

Options Class (cont'd)

```

bool enabled (Option o);

int field_offset (); // Offset from BOL.
Pivot_Strategy pivot_strat ();
int (*compare) (const char *l, const char *r);

protected:
Options (); // Ensure Singleton.

u_long options_; // Maintains options bitmask . . .
int field_offset_;
static Options *instance_; // Singleton.
};

```

Vanderbilt University



84

Options Class (cont'd)

```

#define SET_BIT(WORD, OPTION) (WORD |= OPTION)
#define CLR_BIT(WORD, OPTION) (WORD &= ~OPTION)

bool Options::parse_args (int argc, char *argv[]) {
for (int c;
    (c = getopt (argc, argv, 'nrfs:k:c:t:')) != EOF; ) {
switch (c) {
case 'n': {
CLR_BIT (options_, Options::FOLD);
CLR_BIT (options_, Options::NORMAL);
SET_BIT (options_, Options::NUMERIC);
break;
}
// . . .
}
}

```

Vanderbilt University



85

Using the Options Class

```

// One way to implement sort() comparison operator:
int Line_Ptrs::operator< (const Line_Ptrs &rhs) const {
Options *options = Options::instance ();

if (options->enabled (Options::NORMAL))
return strcmp (this->bof_, rhs.bof_) < 0;
else if (options->enabled (Options::NUMERIC));
return numcmp (this->bof_, rhs.bof_) < 0;
else // if (options->enabled (Options::FOLD))
return strcasecmp (this->bof_, rhs.bof_) < 0;
}

```

- We'll see another approach later on using Bridge

Vanderbilt University



86

Simplifying Comparisons

- *Problem*
 - The comparison operator shown above is somewhat complex
- *Forces*
 - It's better to determine the type of comparison operation during the initialization phase
 - But the interface shouldn't change
- *Solution*
 - Use the *Bridge pattern* to separate interface from implementation

Vanderbilt University



87

The Bridge Pattern

- *Intent*
 - Decouple an abstraction from its implementation so that the two can vary independently
- This pattern resolves the following forces that arise when building extensible software
 1. How to provide a stable, uniform interface that is both closed & open, i.e.,
 - Closed to prevent direct code changes
 - Open to allow extensibility
 2. How to simplify the `Line_Ptrs::operator<` implementation & reference counting for `Access_Table` buffer

Structure of the Bridge Pattern

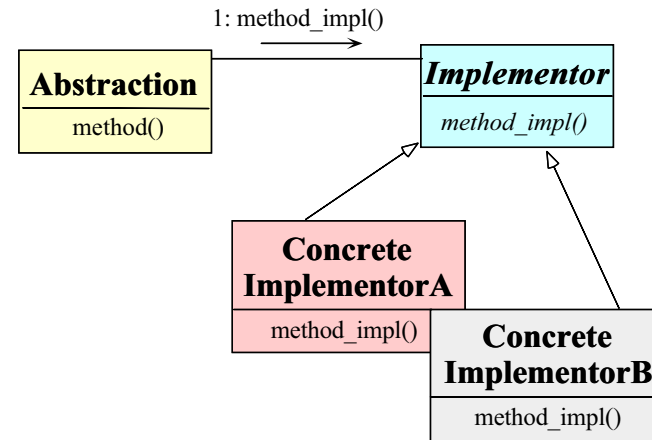

Using the Bridge Pattern

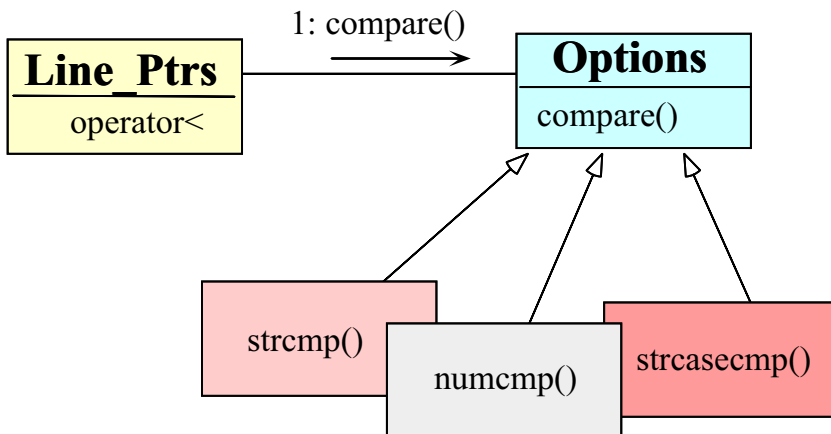

Using the Bridge Pattern

- The following is the comparison operator used by `sort`

```

int Line_Ptrs::operator<(const Line_Ptrs &rhs) const {
    return (*Options::instance ()->compare)
        (bof_, rhs.bof_) < 0;
}

```
- This solution is much more concise
- However, there's an extra level of function call indirection . . .
 - Which is equivalent to a virtual function call

Initializing the Comparison Operator

- *Problem*
 - How does the compare pointer-to-method get assigned?
`int (*compare) (const char *left, const char *right);`
- *Forces*
 - There are many different choices for compare, depending on which options are enabled
 - We only want to worry about initialization details in one place
 - Initialization details may change over time
 - We'd like to do as much work up front to reduce overhead later on
- *Solution*
 - Use a *Factory* pattern to initialize the comparison operator



The Adapter Pattern

- *Intent*
 - *Convert the interface of a class into another interface clients expect*
 - * Adapter lets classes work together that couldn't otherwise because of incompatible interfaces
- This pattern resolves the following forces:
 1. How to transparently integrate the `Access_Table` with the sort routine
 2. How to transparently integrate the `Access_Table` with the C++ `istd::ostream` operators



Structure of the Adapter Pattern

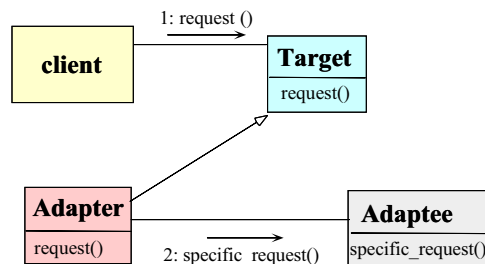

Using the Adapter Pattern

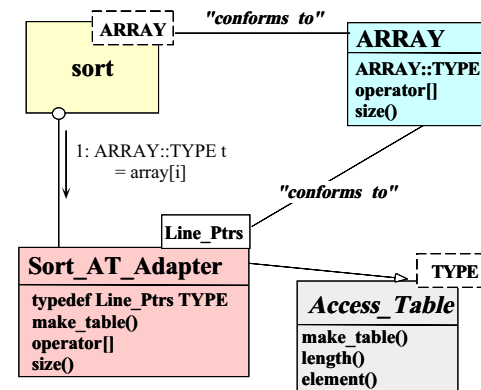

Dynamic Array

- Defines a variable-sized array for use by the Access_Table

```
template <typename T>
class Array {
public:
    Array (size_t size = 0);
    int init (size_t size);
    T &operator[] (size_t index);
    size_t size () const;
    T *begin () const; // STL iterator methods.
    T *end () const;
    // . . .
private:
    T *array_;
    size_t size_;
};
```



The Access_Table Class

- Efficiently maps indices onto elements in the data buffer

```
template <typename T>
class Access_Table {
public:
    // Factory Method for initializing Access_Table.
    virtual int make_table (size_t lines, char *buffer) = 0;
    // Release buffer memory.
    virtual ~Access_Table ();
    T &element (size_t index); // Reference to <indexth> element.
    size_t length () const; // Length of the access_array.
    Array<T> &array (void) const; // Return reference to array.
protected:
    Array<T> access_array_; // Access table is array of T.
    Access_Table_Impl *access_table_impl_; // Ref counted buffer.
};
```



The Access_Table_Impl Class

```
class Access_Table_Impl { // Part of the Bridge pattern
public:
    Access_Table_Impl (void); //Default constructor
    Access_Table_Impl (char *buffer); // Constructor
    // Virtual destructor ensures subclasses are virtual
    virtual ~Access_Table_Impl (void);

    void add_ref (void); // Increment reference count
    void remove_ref (void); // Decrement reference count
    char *get_buffer (void); // Get buffer from the class
    void set_buffer(char *); // Set buffer

private:
    char *buffer_; // Underlying buffer
    size_t ref_count_; // Refcount tracks deletion.
};
```



The Sort_AT_Adapter Class

- Adapts the Access_Table to conform to the ARRAY interface expected by sort

```
struct Line_Ptrs {
    // Comparison operator used by sort().
    int operator< (const Line_Ptrs &) const;

    // Beginning of line & field/column.
    char *bol_, *bof_;
};
```



The Sort_AT_Adapter Class

```
class Sort_AT_Adapter : // Note class form of the Adapter
  private Access_Table<Line_Ptrs> {
public:
  virtual int make_table (size_t num_lines, char *buffer);

  typedef Line_Ptrs TYPE; // Type trait.

  // These methods adapt Access_Table methods . . .
  Line_Ptrs &operator[] (size_t index);
  size_t size () const;
};

// Put these into separate file.
Line_Ptrs &Sort_AT_Adapter::operator[] (size_t i)
{ return element (i); }
size_t Sort_AT_Adapter::size () const { return length (); }
```



The Factory Pattern

- *Intent*
 - Centralize the assembly of resources necessary to create an object
 - * Decouple object creation from object use by localizing creation knowledge
- This pattern resolves the following forces:
 - Decouple initialization of the compare operator from its subsequent use
 - Makes it easier to change comparison policies later on
 - * e.g., adding new command-line options



Structure of the Factory Pattern

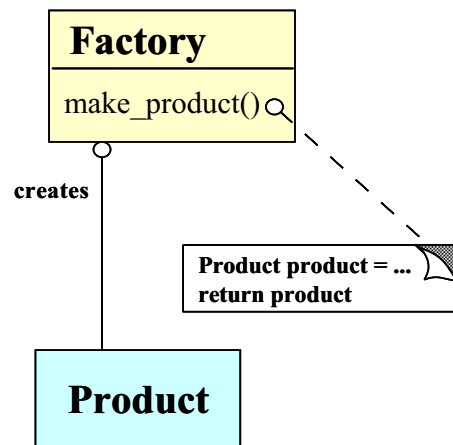

Using the Factory Pattern for Comparisons

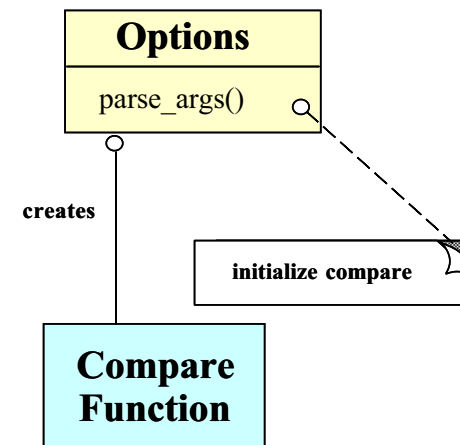

Code for Using the Factory Pattern

- The following initialization is done after command-line options are parsed

```
bool Options::parse_args (int argc, char *argv[])
{
    // . . .
    if (this->enabled (Options::NORMAL))
        this->compare = &strcmp;
    else if (this->enabled (Options::NUMERIC))
        this->compare = &numcmp;
    else if (this->enabled (Options::FOLD))
        this->compare = &strcasecmp;
    // . . .
}
```

Code for Using the Factory Pattern (cont'd)

- We need to write a numcmp() adapter function to conform to the API used by the compare pointer-to-function

```
int numcmp (const char *s1, const char * s2) {
    double d1 = strtod (s1, 0), d2 = strtod (s2, 0);
    if (d1 < d2) return -1;
    else if (d1 > d2) return 1;
    else // if (d1 == d2)
        return 0;
}
```

Initializing the Access_Table

- The following initialization is done after command-line options are parsed

```
bool Options::parse_args (int argc, char *argv[])
{
    // . . .
    if (this->enabled (Options::NORMAL))
        this->compare = &strcmp;
    else if (this->enabled (Options::NUMERIC))
        this->compare = &numcmp;
    else if (this->enabled (Options::FOLD))
        this->compare = &strcasecmp;
    // . . .
}
```

Initializing the Access_Table

- Problem*
 - One of the nastiest parts of the whole system sort program is initializing the Access_Table
- Key forces*
 - We don't want initialization details to affect subsequent processing
 - Makes it easier to change initialization policies later on
 - e.g.*, using the Access_Table in non-sort applications
- Solution*
 - Use the *Factory Method* pattern to initialize the Access_Table

Factory Method Pattern

- Intent*
 - Define an interface for creating an object, but let subclasses decide which class to instantiate
 - Factory Method lets a class defer instantiation to subclasses
- This pattern resolves the following forces:
 - Decouple initialization of the Access_Table from its subsequent use
 - Improves subsequent performance by pre-caching beginning of each field & line
 - Makes it easier to change initialization policies later on
 - e.g.*, adding new command-line options

Structure of the Factory Method Pattern

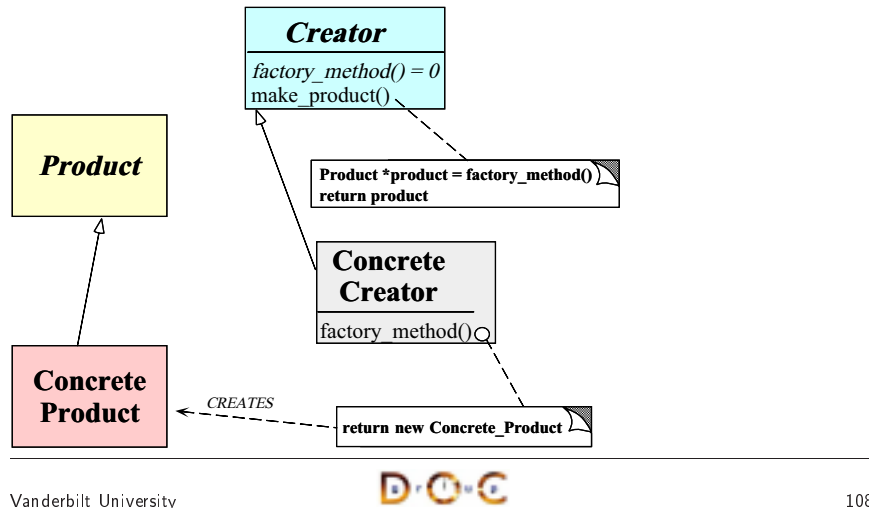

Using the Factory Method Pattern for Access_Table Initialization

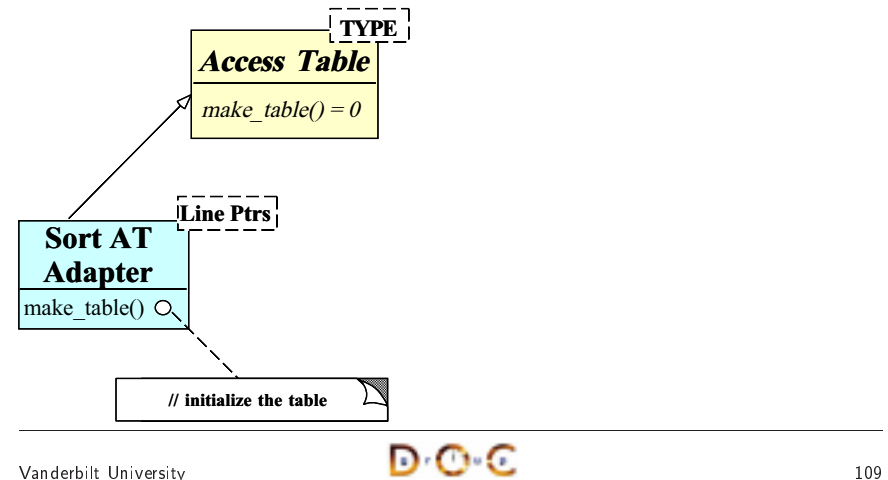

Using the Factory Method Pattern for the Sort_AT_Adapter

- The following `istd::ostream` Adapter initializes the `Sort_AT_Adapter` access table

```

void operator>> (std::istream &is, Sort_AT_Adapter &at)
{
    Input input;
    // Read entire stdin into buffer.
    char *buffer = input.read (is);
    size_t num_lines = input.replaced ();

    // Factory Method initializes Access_Table<>.
    at.make_table (num_lines, buffer);
}
  
```

Implementing the Factory Method Pattern

- The `Access_Table_Factory` class has a Factory Method that initializes `Sort_AT_Adapter`

```

// Factory Method initializes Access_Table.
int Sort_AT_Adapter::make_table (size_t num_lines,
                                char *buffer)
{
    // Array assignment op.
    this->access_array_.resize (num_lines);
    this->buffer_ = buffer; // Obtain ownership.

    size_t count = 0;
  
```

Implementing the Factory Method Pattern (cont'd)

```
// Iterate through the buffer & determine
// where the beginning of lines & fields
// must go.
for (Line_Ptrs_Iter iter (buffer, num_lines);
     iter.is_done () == 0;
     iter.next ())
{
    Line_Ptrs line_ptr = iter.current_element ();
    this->access_array_[count++] = line_ptr;
}
}
```

Vanderbilt University



112

Initializing the Access_Table with Input Buffer

- *Problem*
 - We'd like to initialize the Access_Table *without* having to know the input buffer is represented
- *Key force*
- Representation details can often be decoupled from accessing each item in a container or collection
- *Solution*
 - Use the *Iterator* pattern to scan through the buffer

Vanderbilt University



113

Iterator Pattern

- *Intent*
 - Provide a way to access the elements of an aggregate object sequentially without exposing its underlying representation
- The C++ Standard Library (STL) is heavily based on the iterator pattern, e.g.,

```
int main (int argc, char *argv[]) {
    std::vector <std::string> args;
    for (int i = 1; i < argc; ++i) {
        args.push_back (std::string (argv [i]));
    }
    for (std::vector<std::string>::iterator j = args.begin ();
         j != args.end (); ++j)
        cout << (*j)_ << endl;
    }
```

Iterator Pattern (cont'd)

- The Iterator pattern provides a way to initialize the Access_Table without knowing how the buffer is represented

```
Line_Ptrs_Iter::Line_Ptrs_Iter (char *buffer,
                               size_t num_lines);

Line_Ptrs Line_Ptrs_Iter::current_element () {
    Line_Ptrs lp;
    // Determine beginning of next line \& next field . . .
    lp.bol_ = // . . .
    lp.bof_ = // . . .
    return lp;
}
```

Vanderbilt University



114

Vanderbilt University



115

Iterator Pattern (cont'd)

- Iterator provides a way to print out sorted lines

```
void operator<< (std::ostream &os, const Line_Ptrs lp) {
    os << lp.boL_;
}

void operator<< (std::ostream &os, const Sort_AT_Adapter &at) {
    if (Options::instance ()->enabled (Options::REVERSE))
        std::reverse_copy (
            at.array ().begin (),
            at.array ().end (),
            std::ostream_iterator<System_Sort::Line_Ptrs> (os, "\n"));
    else
        std::copy (
            at.array ().begin (),
            at.array ().end (),
            std::ostream_iterator<System_Sort::Line_Ptrs> (os, "\n"));
}
```

Vanderbilt University



116

Summary of System Sort Case Study

- This case study illustrates using OO techniques to structure a modular, reusable, & highly efficient system
- Design patterns help to resolve many key forces
- Performance of our system sort is comparable to existing UNIX system sort
 - Use of C++ features like *parameterized types* and *inlining* minimizes penalty from increased modularity, abstraction, & extensibility

Vanderbilt University



117

Case Study: Sort Verifier

- *Verify whether a sort routine works correctly*
 - *i.e.*, output of the sort routine must be an ordered permutation of the original input
- This is useful for checking our system sort routine!
 - The solution is harder than it looks at first glance . . .
- As before, we'll examine the key forces & discuss design patterns that resolve the forces

Vanderbilt University



118

General Form of Solution

- The following is a general use-case for this routine:

```
template <typename ARRAY> void sort (ARRAY &a);

template <typename ARRAY> int
check_sort (const ARRAY &o, const ARRAY &p);

int main (int argc, char *argv[])
{
    Options::instance ()->parse_args (argc, argv);

    Input original;
    Input potentially_sorted;
```

Vanderbilt University



119

General Form of Solution (cont'd)

```

cin >> input;

std::copy (original.begin (),
          original.end (),
          potentially_sorted.begin ());
sort (potentially_sorted);

if (check_sort (original, potentially_sorted) == -1)
    cerr << "sort failed" << endl;
else
    cout << "sort worked" << endl;
}

```

Common Problems

unsorted	7	13	4	15	18	13	8	4
sorted, but not permuted	0	0	0	0	0	0	0	0
permuted, but not sorted	8	13	18	15	4	13	4	7
sorted and permuted	4	4	7	8	13	13	15	18

- Several common problems:
 - Sort routine may zero out data
 - * though it will appear sorted . . . ;-)
 - Sort routine may fail to sort data
 - Sort routine may erroneously add new values

Forces

- Solution should be both time & space efficient
 - e.g., it should not take more time to check than to sort in the first place!
 - Also, this routine may be run many times consecutively, which may facilitate certain space optimizations
- We cannot assume the existence of a “correct” sorting algorithm . . .
 - Therefore, to improve the chance that our solution is correct, it must be simpler than writing a correct sorting routine
 - * *Quis custodiet ipsos custodes?*
 - (Who shall guard the guardians?)

Forces (cont'd)

- Multiple implementations will be necessary, depending on properties of the data being examined, e.g.,
 1. if data values are small (in relation to number of items) & integrals use . . .
 2. if data has no duplicate values use . . .
 3. if data has duplicate values use . . .
- This problem illustrates a simple example of “program families”
 - i.e., we want to reuse as much code and/or design across multiple solutions as possible

Strategies

- Implementations of search structure vary according to data, e.g.,
 1. *Range Vector*
 - $O(N)$ time complexity & space efficient for sorting “small” ranges of integral values
 2. *Binary Search* (version 1)
 - $O(n \log n)$ time complexity & space efficient but does not handle duplicates
 3. *Binary Search* (version 2)
 - $O(n \log n)$ time complexity, but handles duplicates
 4. *Hashing*
 - $O(n)$ best/average case, but $O(n^2)$ worst case, handles duplicates, but potentially not as space efficient

General OOD Solution Approach

- Identify the “objects” in the application & solution space
 - e.g., use a *search structure* ADT organization with member function such as insert & remove
- Recognize common design patterns
 - e.g., Strategy & Factory Method
- Implement a framework to coordinate multiple implementations
 - e.g., use classes, parameterized types, inheritance & dynamic binding

General OOD solution approach (cont'd)

- C++ framework should be amenable to:
 - *Extension & Contraction*
 - * May discover better implementations
 - * May need to conform to resource constraints
 - * May need to work on multiple types of data
 - *Performance Enhancement*
 - * May discover better ways to allocate & cache memory
 - * Note, improvements should be transparent to existing code . . .
 - *Portability*
 - * May need to run on multiple platforms

- e.g., pseudo code

```
template <typename ARRAY>
int check_sort (const ARRAY &original,
               const ARRAY &potential_sort)
{
```

```
    Perform basic sanity check to see if the
    potential_sort is actually in order
    (can also detect duplicates here)
```



High-level Algorithm (cont'd)

```

if (basic sanity check succeeds) then
  Initialize search structure, srchstrct
  for i < 0 to size - 1 loop
    insert (potential_sort[i])
    into srchstrct
  for i < 0 to size - 1 loop
    if remove (original[i]) from
      srchstrct fails then
      return ERROR
  return SUCCESS
else
  return ERROR
end if
}

```

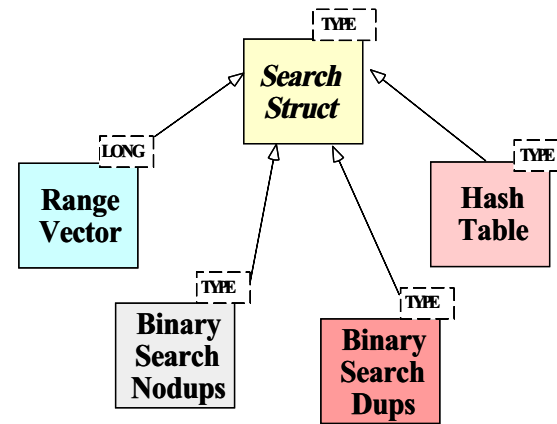
UML Class Diagram for C++ Solution



C++ Class Interfaces

- Search structure base class.

```

template <typename T>
class Search_Strategy
{
public:
  virtual bool insert (const T &new_item) = 0;
  virtual bool remove (const T &existing_item) = 0;
  virtual ~Search_Strategy () = 0;
};

```

C++ Class interfaces (cont'd)

- Strategy Factory class

```

template <typename ARRAY>
Search_Struct
{
public:
  // Singleton method.
  static Search_Struct<ARRAY> *instance ();

  // Factory Method
  virtual Search_Strategy<typename ARRAY::TYPE> *
    make_strategy (const ARRAY &);
};

```

C++ Class interfaces (cont'd)

- Strategy subclasses

```
// Note the template specialization
class Range_Vector :
    public Search_Strategy<long>
{ typedef long TYPE; /* . . . */ };

template <typename ARRAY>
class Binary_Search_Nodups :
    public Search_Strategy<typename ARRAY::TYPE>
{
    typedef typename ARRAY::TYPE TYPE; /* . . . */
};
```

C++ Class interfaces (cont'd)

```
template <typename ARRAY> class Binary_Search_Dups :
    public Search_Strategy<typename ARRAY::TYPE>
{
    typedef typename ARRAY::TYPE TYPE; /* . . . */
};

template <typename T>
class Hash_Table :
    public Search_Strategy<T>
{
    typedef typename ARRAY::TYPE TYPE; /* . . . */
};
```

Design Patterns in Sort Verifier

- Factory Method
 - *Define an interface for creating an object, but let subclasses decide which class to instantiate*
 - * Factory Method lets a class defer instantiation to subclasses
- In addition, the *Facade*, *Iterator*, *Singleton*, & *Strategy* patterns are used

Using the Strategy Pattern

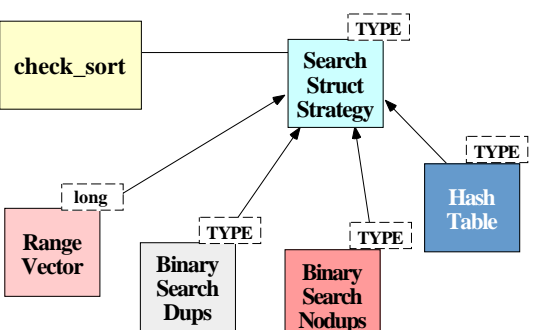

- This pattern extends the strategies for checking if an array is sorted without modifying the `check_sort` algorithm

The Factory Method Pattern

- *Intent*
 - Define an interface for creating an object, but let subclasses decide which class to instantiate
 - * Factory Method lets a class defer instantiation to subclasses
- This pattern resolves the following force:
 1. *How to extend the initialization strategy in the sort verifier transparently*

Structure of the Factory Method Pattern

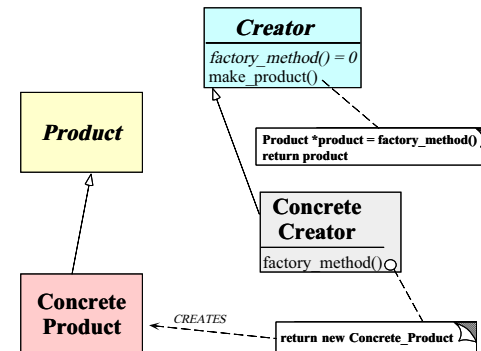

Using the Factory Method Pattern

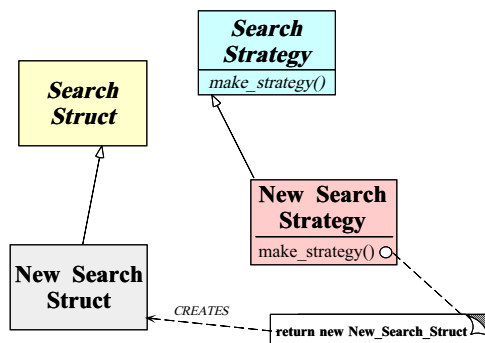

Implementing the check_sort Function

- e.g., C++ code for the sort verification strategy

```

template <typename ARRAY> int
check_sort (const ARRAY &orig,
            const ARRAY &p_sort) {
    if (orig.size () != p_sort.size ())
        return -1;

    auto_ptr < Search_Strategy<typename ARRAY::TYPE> > ss =
        Search_Struct<ARRAY>::instance ()->make_strategy
        (p_sort);
    
```

Implementing the check_sort Function (cont'd)

```
for (int i = 0; i < p_sort.size (); ++i)
    if (ss->insert (p_sort[i]) == false)
        return -1;

for (int i = 0; i < orig.size (); ++i)
    if (ss->remove (orig[i]) == false)
        return -1;

return 0;
// auto_ptr's destructor deletes the memory . . .
}
```

Initializing the Search Structure

- Factory Method

```
template <typename ARRAY>
Search_Struct<typename ARRAY::TYPE> *
Search_Struct<ARRAY>::make_strategy
(const ARRAY &potential_sort) {
    int duplicates = 0;

    for (size_t i = 1; i < potential_sort.size (); ++i)
        if (potential_sort[i] < potential_sort[i - 1])
            return 0;
        else if (potential_sort[i] == potential_sort[i - 1])
            ++duplicates;
```

Initializing the Search Structure (cont'd)

```
if (typeid (potential_sort[0]) == typeid (long)
    && range <= size)
    return new Range_Vector (potential_sort[0],
                             potential_sort[size - 1])
        else if (duplicates == 0)
            return new Binary_Search_Dups<ARRAY>
                (potential_sort);
        else if (size % 2)
            return new Binary_Search_Dups<ARRAY>
                (potential_sort, duplicates)
        else return new Hash_Table<typename ARRAY::TYPE>
            (size, &hash_function);
}
```

Specializing the Search Structure for Range Vectors

```
template <Array<long> > Search_Strategy<long> *
Search_Struct<Array<long> >::make_strategy
(const Array<long> &potential_sort)
{
    int duplicates = 0;

    for (size_t i = 1; i < size; ++i)
        if (potential_sort[i] < potential_sort[i - 1])
            return 0;
        else if (potential_sort[i] == potential_sort[i - 1])
            ++duplicates;

    long range = potential_sort[size - 1] -
        potential_sort[0];
```

Specializing the Search Structure for Range Vectors

```
if (range <= size)
    return new Range_Vector (potential_sort[0],
                             potential_sort[size - 1])
else if (duplicates == 0)
    return new Binary_Search_NoDups<long>
        (potential_sort);
else if (size % 2)
    return new Binary_Search_Dups<long>
        (potential_sort, duplicates)
else return new Hash_Table<long>
        (size, &hash_function);
}
```

Summary of Sort Verifier Case Study

- The sort verifier illustrates how to use OO techniques to structure a modular, extensible, & efficient solution
 - The main processing algorithm is simplified
 - The complexity is pushed into the strategy objects & the strategy selection factory
 - Adding new solutions does not affect existing code
 - The appropriate ADT search structure is selected at run-time based on the Strategy pattern