

Hot Topics in Networking

ATM

IP Switching

Gigabit Ethernet

Voice over IP

Differentiated Services

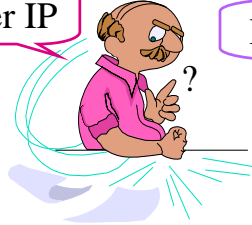

Raj Jain

Profe

ences

Raj Jain is now at
Washington University in Saint Louis
Jain@cse.wustl.edu
<http://www.cse.wustl.edu/~jain/>

Raj Jain

1



- Networking Trends
- ATM Networks
- LAN Emulation, MPOA, IP/Tag/Label Switching
- Gigabit Ethernet

Raj Jain

2

Networking Trends

- Impact of Networking
- Networking Trends
- Telecommunication Trends
- Current Research Topics

Raj Jain

3

ATM Networks

- ATM vs Phone Networks and Data Networks
- ATM Protocol Layers
- Cell Header Format, AALs
- Physical Media
- Traffic Management: ABR, UBR, GFR
- Success of ATM: Issues and Challenges

Raj Jain

4

LAN Emulation and IP Switching

- LAN Emulation
- Classical IP over ATM
- Next Hop Resolution Protocol (NHRP)
- Multiprotocol over ATM(MPOA)
- IP Switching (Ipsilon)
- Tag Switching (CISCO)
- Multi-protocol label switching

Raj Jain

5

Gigabit Ethernet

- Distance-Bandwidth Principle
- 10 Mbps to 100 Mbps
- Gigabit PHY and MAC Issues
- ATM vs Gigabit Ethernet
- 1000BASE-T for 1 Gbps over UTP5
- Link aggregation

Raj Jain

6

Schedule (Tentative)

- 10:00-11:30 Course Introduction/Trends
- 11:30-12:00 ATM Networks
- 12:00-1:00 *Lunch Break*
- 1:00-2:00 ATM Networks (Cont)
- 2:00-2:15 *Stretch Break*
- 2:15-3:30 IP Switching
- 3:30-3:45 *Coffee Break*
- 3:45-5:00 Gigabit Ethernet

Raj Jain

7

References

- You can get to all on-line references via:
http://www.cis.ohio-state.edu/~jain/refs/hot_refs.htm

Raj Jain

8

Pre-Test

Check if you know the difference between:

- AAL2 and AAL5
- LAN emulation and Classical IP over ATM
- GFR and UBR
- ARP and NHRP
- LANE and MPOA
- Tag Switching and Label Switching
- CSMA/CA and CSMA/CD
- Min packet sizes on 10Base-T and 1000Base-T
- Carrier Extension and Packet Bursting

Number of items checked _____

Raj Jain

Pre-Test (Cont)

- If you checked more than 5 items, you may not gain much from this course.
- If you checked only a few or none, don't worry. This course will cover all this and much more.

Raj Jain

Disclaimer

- ❑ The technologies are currently evolving.
⇒ Many statements are subject to change.
- ❑ Features not in a technology may be implemented later in that technology.
- ❑ Problems claimed to be in a technology may later not be a problem.

Raj Jain

11

Raj Jain

12

Networking Trends and Their Impact



Raj Jain
The Ohio State University
Columbus, OH 43210
Jain@CIS.Ohio-State.Edu

<http://www.cis.ohio-state.edu/~jain/>

Raj Jain

13



- Impact of Networking
- Networking Trends
- Telecommunication Trends
- Current Research Topics

Raj Jain

15

Trends

- ❑ Communication is more critical than computing
 - Greeting cards contain more computing power than all computers before 1950.
 - Genesis's game has more processing than 1976 Cray supercomputer.
- ❑ Internet: 0.3 M hosts in Jan 91 to 9.5 M by Jan 96
⇒ More than 5 billion (world population) in 2003

Raj Jain

16

Garden Path to I-Way

- ❑ Plain Old Telephone System (POTS)
= 64 kbps = 3 ft garden path
- ❑ ISDN = 128 kbps = 6 ft sidewalk
- ❑ T1 Links to Businesses = 1.544 Mbps
= 72 ft = 4 Lane roadway
- ❑ Cable Modem Service to Homes:
= 10 Mbps = 470 ft = 26 Lane Driveway
- ❑ OC3 = 155 Mbps = 1 Mile wide superhighway
- ❑ OC48 = 2.4 Gbps = 16 Mile wide superhighway
- ❑ OC768 = 38.4 Gbps = 256 Mile wide superhighway



Raj Jain

19

Life Cycles of Technologies

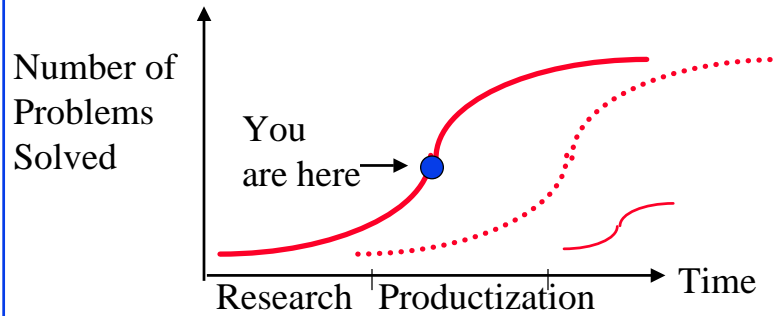

Raj Jain

20

Internet Technology

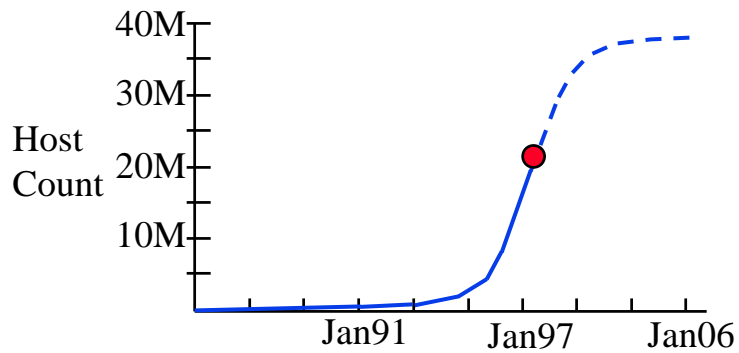

- **New Challenges:** Exponential growth in number of users. Exponential growth in bandwidth per user. Traffic management, Security, Usability, ...

Raj Jain

21

Impact on R&D

- ❑ Too much growth in one year
 - ⇒ Can't plan too much into long term
- ❑ Long term = 1₂ year or 10₂ years at most
- ❑ Products have life span of 1 year, 1 month, ...
- ❑ Short product development cycles.
Chrysler reduced new car design time from 6 years to 2.
- ❑ Distance between research and products has narrowed
 - ⇒ Collaboration between researchers and developers
 - ⇒ Academics need to participate in industry consortia

Raj Jain

23

New Challenges

- ❑ Networking is moving from specialists to masses ⇒ Usability (plug & play), security
- ❑ Exponential growth in number of users + Exponential growth in bandwidth per user ⇒ Traffic management
- ❑ Standards based networking for reduced cost
 - ⇒ Important to participate in standardization forums
ATM Forum, Frame Relay Forum, ...
Internet Engineering Task Force (IETF),
Institute of Electrical and Electronic Engineers (IEEE)
International Telecommunications Union (ITU), ...

Raj Jain

24

Networking Trends

- ❑ Inter-Planetary Networks \Rightarrow Distances are increasing
- ❑ WDM OC-768 Networks = 39.8 Gb/s
 - \Rightarrow Bandwidth is increasing
 - \Rightarrow Large Bandwidth-Delay Product Networks
- ❑ Copper is still in.
6-27 Mbps on phone wire. Fiber is being postponed.
- ❑ Shared LANs to Switched LANs
- ❑ Routing to Switching. Distinction is disappearing
- ❑ LANs and PBX's to Integrated LANs
- ❑ Bandwidth requirements are doubling every 4 months

Raj Jain

25

Telecommunication Trends

- ❑ Voice traffic is growing linearly
Data traffic is growing exponentially
- ❑ Carriers are converting to ATM
- ❑ Integrated voice, video, data (internet services)
- ❑ High-speed frame relay
- ❑ xDSL \Rightarrow Competitive local exchange carriers (CLEC)
- ❑ Cable Modems
- ❑ Voice over IP

Raj Jain

26

Research Topics

- ❑ Terabit networking: Wavelength division multiplexing, all-optical switching
- ❑ High-speed access from home
 - ⇒ Robust and high-bandwidth encoding techniques
- ❑ High-speed Wireless = More than 10 bit/Hz
28.8 kbps on 30 kHz cellular ⇒ 1 bit/Hz
- ❑ Traffic management, quality of service, multicasting:
 - Ethernet LANs, IP networks, ATM Networks
- ❑ Mobility
- ❑ Large network management Issues.

Raj Jain

27

Research Topics (Cont)

- ❑ Information Glut ⇒ Intelligent agents for searching, digesting, summarizing information
- ❑ Scalable Voice/Video compression:
2400 bps to 1.5 Mbps video, 8 kbps voice
- ❑ Electronic commerce ⇒ Security, privacy, cybercash
- ❑ Active Networks ⇒ A "program" in place of addresses

Raj Jain

28

Summary

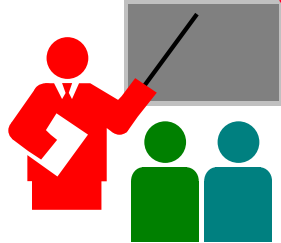

- ❑ Networking is the key to productivity
- ❑ It is impacting all aspects of life \Rightarrow Networking Age
- ❑ Profusion of Information
- ❑ Collaboration between researchers and developers
- ❑ Usability, security, traffic management

Raj Jain

29

Key References

- ❑ See http://www.cis.ohio-state.edu/~jain/refs/ref_trnd.htm
- ❑ "The Next 50 years," Special issue of Communications of the ACM, Feb 1997.
- ❑ D. Tapscott, "The Digital Economy: Promise and Peril in the Age of Networked Intelligence," McGraw-Hill, 1995.
- ❑ T. Lewis, "The Next 10,000₂ years," IEEE Computer, April/May 1996

Raj Jain

30



31

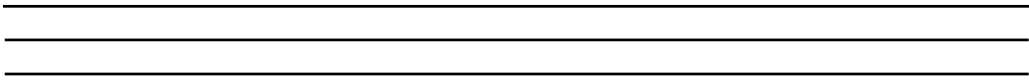

32

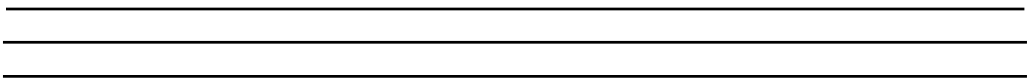

ATM Networks: An Overview

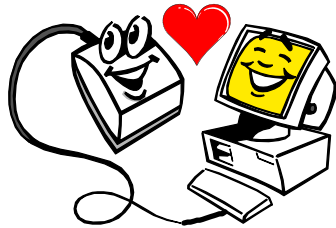

Raj Jain

Professor of Computer and Information Sciences

The Ohio State University

Columbus, OH 43210-1277

<http://www.cis.ohio-state.edu/~jain/>

Raj Jain

33



- ATM vs Phone Networks and Data Networks
- ATM Protocol Layers
- Cell Header Format, AALs
- Physical Media
- Traffic Management: ABR, UBR, GFR
- Success of ATM: Issues and Challenges

Raj Jain

34

ATM

- ATM Net = Data Net + Phone Net
- Combination of Internet method of communication (packet switching) and phone companies' method (circuit switching)

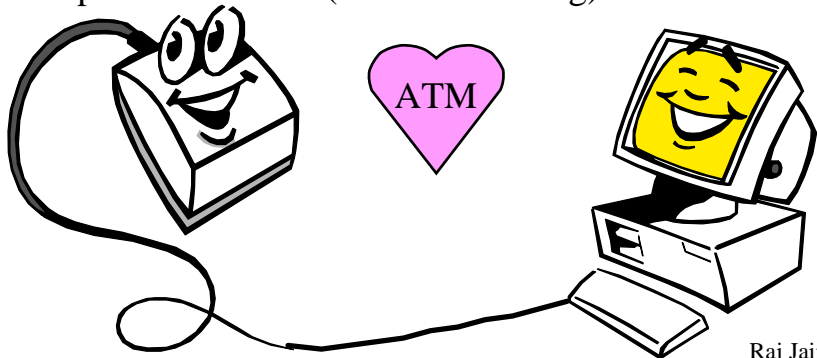

35

ATM vs Phone Networks

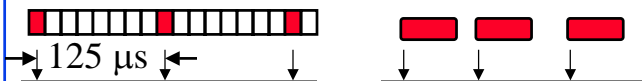

- Current phone networks are synchronous (periodic).
ATM = Asynchronous Transfer Mode
- Phone networks use circuit switching.
ATM networks use “Packet” Switching
- In phone networks, all rates are multiple of 8 kbps.
With ATM service, you can get any rate.
You can vary your rate with time.
- With current phone networks, all high speed circuits are manually setup. ATM allows dialing any speed.

Raj Jain

36

ATM vs Data Networks

- ❑ Signaling: Internet Protocol (IP) is connectionless. You cannot reserve bandwidth in advance. ATM is connection-oriented. You declare your needs before using the network.
- ❑ PNNI: Path based on quality of service (QoS)
- ❑ Switching: In IP, each packet is addressed and processed individually.
- ❑ Traffic Management: Loss based in IP. ATM has 1996 traffic management technology. Required for high-speed and variable demands.
- ❑ Cells: Fixed size or small size is not important

Raj Jain

37

ATM Interfaces

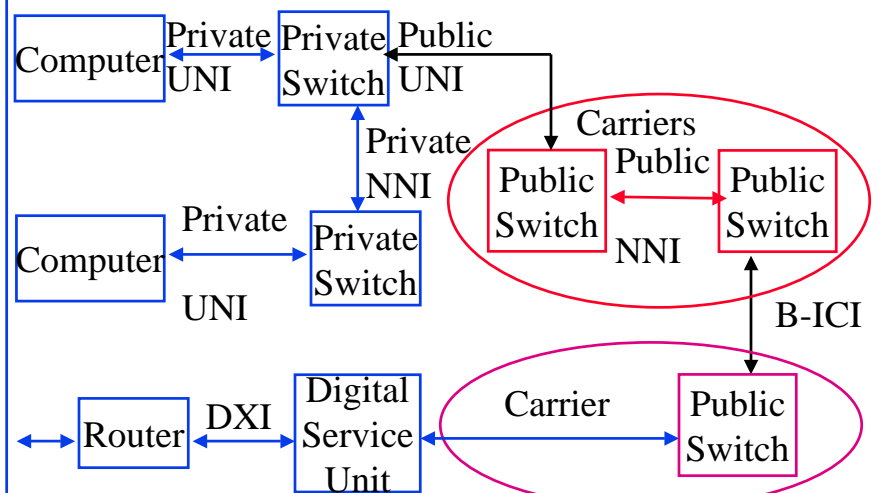

Raj Jain

39

ATM Interfaces

- User to Network Interface (UNI):
Public UNI, Private UNI
- Network to Node Interface (NNI):
 - Private NNI (P-NNI)
 - Public NNI = Inter-Switching System Interface (ISSI)
Intra-LATA ISSI (Regional Bell Operating Co)
 - Inter-LATA ISSI (Inter-exchange Carriers)
⇒ Broadband Inter-Carrier Interface (B-ICI)
- Data Exchange Interface (DXI)
Between routers and ATM Digital Service Units (DSU)

Raj Jain

40

Protocol Layers

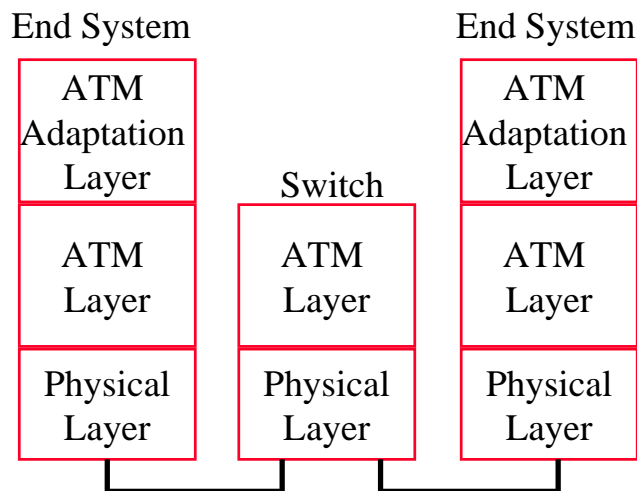

Raj Jain

41

Protocol Layers

- ❑ The ATM Adaptation Layer
 - How to break messages to cells
- ❑ The ATM Layer
 - Transmission/Switching/Reception
 - Congestion Control/Buffer management
 - Cell header generation/removal at source/destination
 - Cell address translation
 - Sequential delivery

Raj Jain

42

Cell Header Format

- ❑ GFC = Generic Flow Control
 - (Was used in UNI but not in NNI)
- ❑ VPI/VCI = 0/0 \Rightarrow Idle cell; 0/n \Rightarrow Signaling
- ❑ HEC: $1 + x + x^2 + x^8$

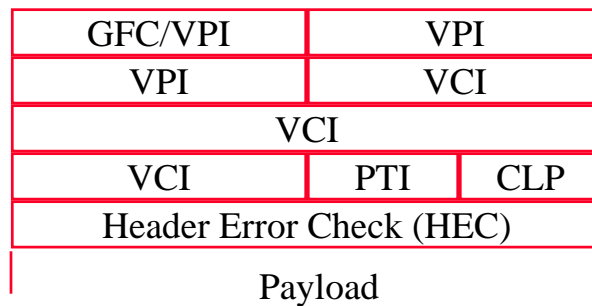

Raj Jain

43

Path vs Channels

- 24/28-bit connection identifier
 First 8/12 bits: Virtual Path,
 Last 16 bits: Virtual Circuit
- VP service allows new VC's w/o orders to carriers

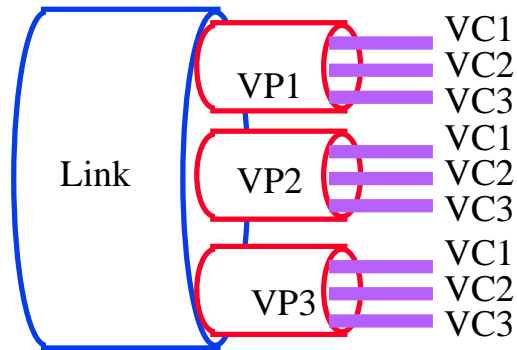

Raj Jain

VP/VC Assignment/Use

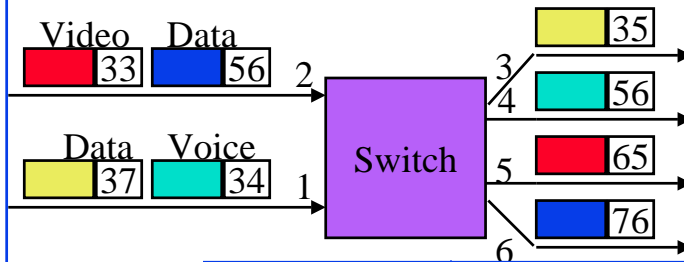

In		Out	
Port	VPI/VCI	Port	VPI/VCI
1	0/37	3	1/35
1	0/34	4	0/56
2	0/33	5	0/65
2	0/56	6	4/76

Raj Jain

Original Classes of Traffic

	Class A	Class B	Class C	Class D
Time Sync	Yes	Yes	No	No
Bit Rate	Constant	Variable	Variable	Variable
Connection-Oriented	Yes	Yes	Yes	No
Examples	Circuit Emulation	Comp. Video	Frame Relay	SMDS
AAL	AAL1	AAL2	AAL3	AAL4

Raj Jain

46

AAL 5

- ❑ Designed for data traffic
- ❑ Less overhead bits than AAL 3/4
Simple and Efficient AAL (SEAL)
- ❑ No per cell length field, No per cell CRC

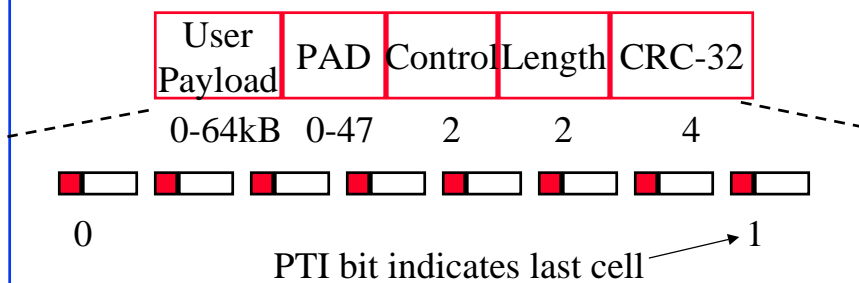

Raj Jain

47

AAL2

- ❑ Ideal for low bit rate voice
- ❑ Variable/constant rate voice
- ❑ Multiple users per VC
- ❑ Compression and Silence suppression
- ❑ Idle channel suppression

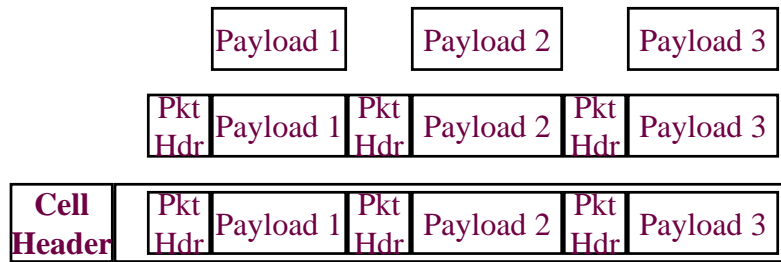

Raj Jain

48

Physical Media

- ❑ Multimode Fiber: 100 Mbps using 4b/5b, 155 Mbps SONET STS-3c, 155 Mbps 8b/10b
- ❑ Single-mode Fiber: 155 Mbps STS-3c, 622 Mbps
- ❑ Plastic Optical Fiber: 155 Mbps
- ❑ Shielded Twisted Pair (STP): 155 Mbps 8b/10b
- ❑ Coax: 45 Mbps, DS3, 155 Mbps
- ❑ Unshielded Twisted Pair (UTP)
 - UTP-3 (phone wire) at 25.6, 51.84, 155 Mbps
 - UTP-5 (Data grade UTP) at 155 Mbps
- ❑ DS1, DS3, STS-3c, STM-1, E1, E3, J2, $n \times T1$

Raj Jain

49

Classes of Service

- ❑ **ABR** (Available bit rate):
Source follows network feedback.
Max throughput with minimum loss.
- ❑ **UBR** (Unspecified bit rate):
User sends whenever it wants. No feedback. No guarantee. Cells may be dropped during congestion.
- ❑ **CBR** (Constant bit rate): User declares required rate.
Throughput, delay and delay variation guaranteed.
- ❑ **VBR** (Variable bit rate): Declare avg and max rate.
 - **rt-VBR** (Real-time): Conferencing.
Max delay guaranteed.
 - **nrt-VBR** (non-real time): Stored video.

Raj Jain

51

ABR vs UBR for TCP/IP

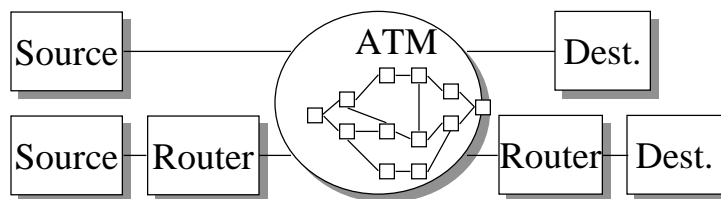

ABR

Queue in the source
Pushes congestion to edges
Good if end-to-end ATM
Fair
Good for the provider

UBR

Queue in the network
No backpressure
Same end-to-end or backbone
Generally unfair
Simple for user

Raj Jain

53

Guaranteed Frame Rate (GFR)

- ❑ UBR with minimum cell rate (MCR) \Rightarrow UBR+
- ❑ Frame based service
 - Complete frames are accepted or discarded in the switch
 - Traffic shaping is frame based.
All cells of the frame have the same cell loss priority (CLP)
 - All frames below MCR are given CLP =0 service.
All frames above MCR are given best effort (CLP =1) service.

Raj Jain

54

Networking: Failures vs Successes

- ❑ 1980: Broadband (vs baseband)
- ❑ 1981: PBX (vs Ethernet)
- ❑ 1984: ISDN (vs Modems)
- ❑ 1986: MAP/TOP (vs Ethernet)
- ❑ 1988: OSI (vs TCP/IP)
- ❑ 1991: DQDB
- ❑ 1992: XTP (vs TCP)
- ❑ 1994: CMIP (vs SNMP)

Raj Jain

57

Requirements for Success

- ❑ Low Cost
- ❑ High Performance
- ❑ Killer Applications
- ❑ Timely completion
- ❑ Manageability
- ❑ Interoperability
- ❑ Coexistence with legacy LANs
Existing infrastructure is more important than new technology



Raj Jain

58

Economy of Scale

- ❑ Technology is far ahead of the applications.
Invention is becoming the mother of necessity.
We have high speed fibers, but no video traffic.
- ❑ Low-cost is the primary motivator. Not necessity.
⇒ Buyer's market (Like \$99 airline tickets.)
Why? vs Why not?
- ❑ Ten 100-MIPS computer cheaper than a 1000-MIPS
⇒ Parallel computing, not supercomputing
- ❑ Ethernet was and is cheaper than 10 one-Mbps links.
- ❑ No FDDI if it is 10 times as expensive as Ethernet.
10/100 Ethernet adapters = \$50 over 10 Mbps

Raj Jain

59

Challenge: Tariff

- ❑ Phone company's goal: How to keep the voice business and get into data too?
- ❑ Customer's goal: How to transmit the data cheaper?
- ❑ Tariff Today:
 - 64 kbps voice line = \$300/year
 - 45 Mbps line (\$45/mile/month)
Coast to coast = \$180 k-240 k/year
⇒ 155 Mbps line = \$540 k - \$720 k/year
- ❑ Tomorrow: 155 Mbps = \$1k/month+ \$28/G cells
⇒ \$13k - \$45k/year

Raj Jain

60

Summary

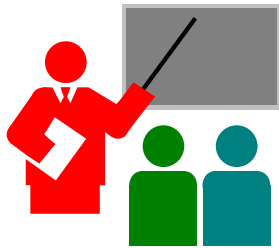

- ❑ ATM Overview: History, Why and What
- ❑ Protocol Layers: AAL, ATM, Physical layers, Cell format
- ❑ Interfaces: PNNI, NNI, B-ICI, DXI
- ❑ ABR, CBR, VBR, UBR, GFR

Raj Jain

61

ATM : Key References

- ❑ See http://www.cis.ohio-state.edu/~jain/refs/atm_refs.htm
- ❑ G. Sackett and C. Y. Metz, “ATM and Multiprotocol Networking,” McGraw-Hill, 1997 (Technical).
- ❑ ATM Forum specs are available at <ftp://ftp.atmforum.com/pub/approved-specs/>
- ❑ R. Jain, “ATM Networks: Issues and Challenges ahead,” NetWorld+Interop Engineering Conference, March 1995. Available on <http://www.cis.ohio-state.edu/~jain/>

Raj Jain

Raj Jain



Raj Jain

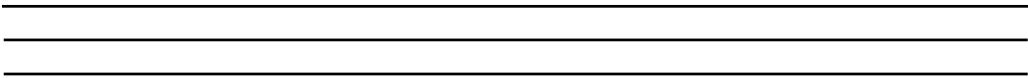

Raj Jain

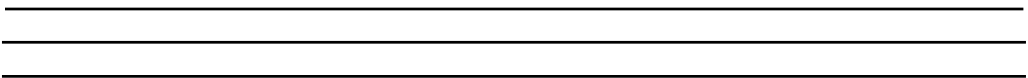

LAN Emulation, IP Switching and Label Switching

Raj Jain
Professor of Computer and Information Sciences
The Ohio State University

<http://www.cis.ohio-state.edu/~jain/>

Raj Jain

66



- ❑ LAN Emulation
- ❑ Classical IP over ATM
- ❑ Next Hop Resolution Protocol (NHRP)
- ❑ Multiprotocol over ATM(MPOA)
- ❑ IP Switching (Ipsilon)
- ❑ Tag Switching (CISCO)
- ❑ Multi-protocol label switching

Raj Jain

67

LAN Emulation

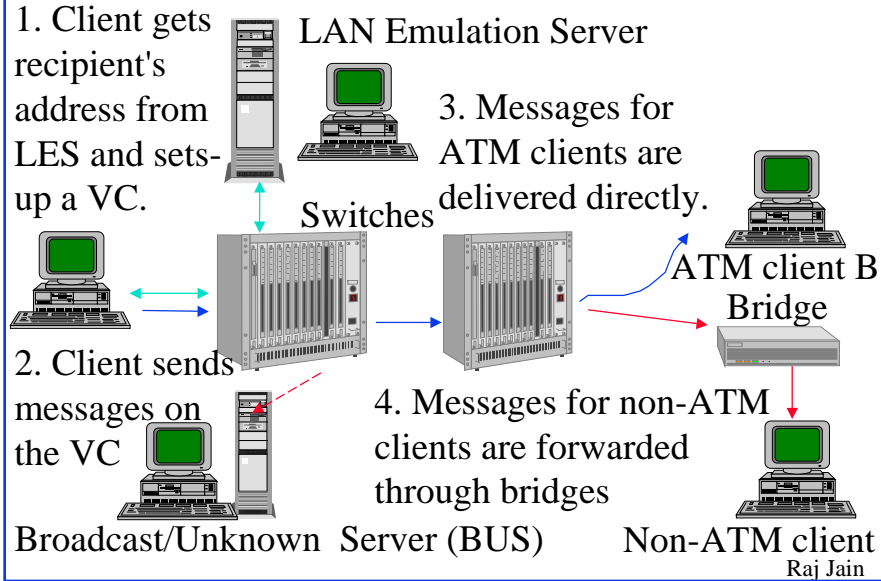

70

ATM Virtual LANs

Physical View

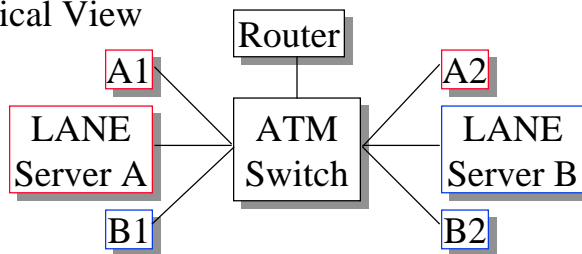

Logical View

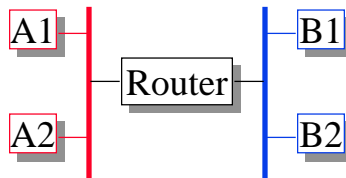

Raj Jain

71

Classical IP Over ATM

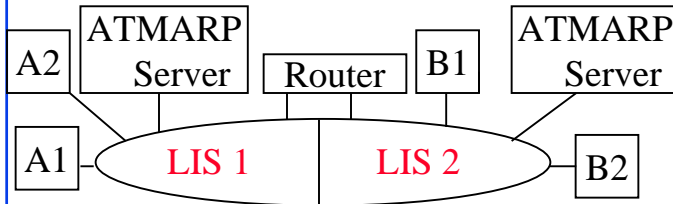

- ❑ ATM stations are divided into Logical IP Subnets (LIS)
- ❑ ATMARP server translates IP addresses to ATM addresses.
- ❑ Each LIS has an ATMARP server for resolution
- ❑ IP stations set up a direct VC with the destination or the router and exchange packets.

Raj Jain

73

IP Multicast over ATM

- ❑ Multicast Address Resolution Servers (MARS)
- ❑ Internet Group Multicast Protocol (IGMP)
- ❑ Multicast group members send IGMP join/leave messages to MARS
- ❑ Hosts wishing to send a multicast send a resolution request to MARS
- ❑ MARS returns the list of addresses
- ❑ MARS distributes membership update information to all cluster members

Raj Jain

74

Next Hop Resolution Protocol

- ❑ Routers assemble packets \Rightarrow Slow
- ❑ NHRP servers can provide ATM address for the edge device to any IP host
- ❑ Can avoid routers if both source and destination are on the same ATM network.

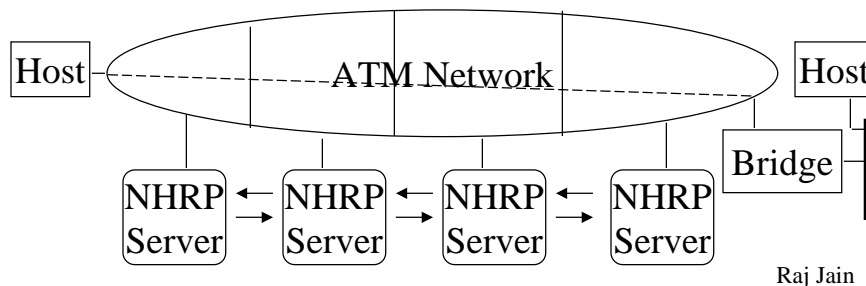

75

Multiprotocol Over ATM

- ❑ MPOA = LANE + "NHRP+"
- ❑ Extension of LANE
- ❑ Uses NHRP to find the shortcut to the next hop
- ❑ No routing (reassembly) in the ATM network

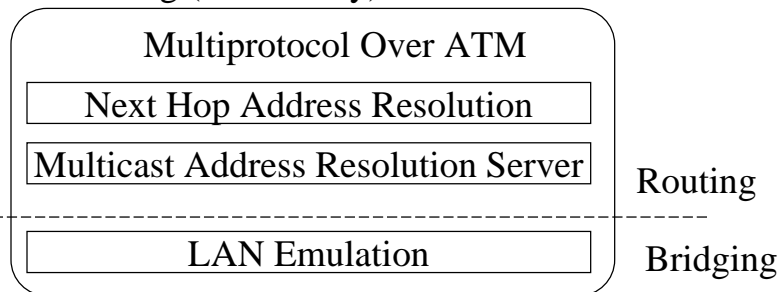

Raj Jain

76

MPOA (Cont)

- ❑ LANE operates at layer 2
- ❑ RFC 1577 operates at layer 3
- ❑ MPOA operates at both layer 2 and layer 3
 - ⇒ MPOA can handle non-routable as well as routable protocols
- ❑ Layer 3 protocol runs directly over ATM
 - ⇒ Can use ATM QoS
- ❑ MPOA uses LANE for its layer 2 forwarding

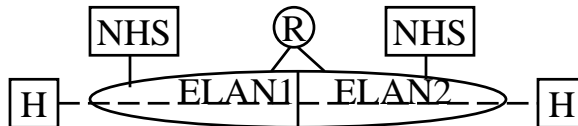

Raj Jain

77

IP Switching

- ❑ Developed by Ipsilon
- ❑ Routing software in every ATM switch in the network
- ❑ Initially, packets are reassembled by the routing software and forwarded to the next hop
- ❑ Long term flows are transferred to separate VCs. Mapping of VCIs in the switch ⇒ No reassembly

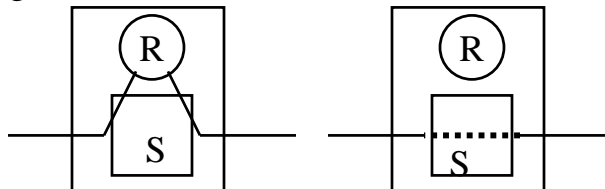

Raj Jain

78

IP Switching: Steps 1-2

- If a flow is deemed to be "flow oriented", the node asks the upstream node to set up a separate VC.
- Downstream nodes may also ask for a new VC.

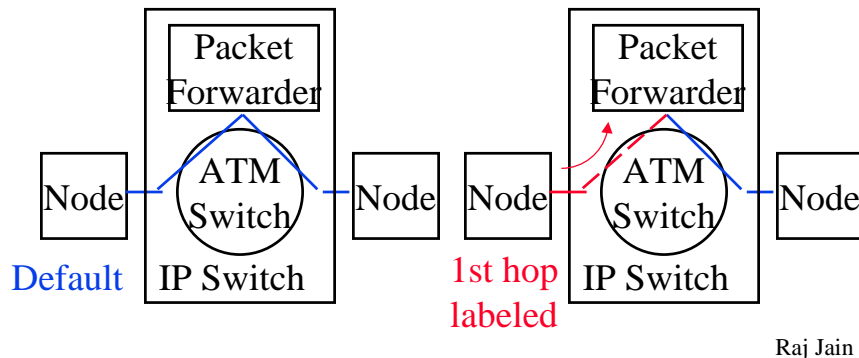

79

IP Switching: Steps 3, 4

- After both sides of a flow have separate VCs, the router tells the switch to register the mapping for cut-through

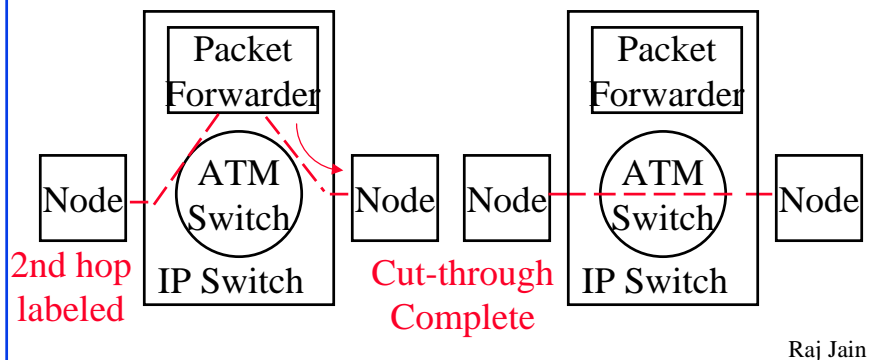

80

IP Switching (Cont)

- ❑ Flow-oriented traffic: FTP, Telnet, HTTP, Multimedia
- ❑ Short-lived Traffic: DNS query, SMTP, NTP, SNMP, request-response
Ipsilon claims that 80% of packets and 90% of bytes are flow-oriented.
- ❑ IP switching implemented as a s/w layer over an ATM switch
- ❑ Ipsilon claims their Generic Switch Management Protocol (GSMP) to be 2000 lines, and Ipsilon Flow Management Protocol (IFMP) to be only 10,000 lines of code

Raj Jain

81

Ipsilon's IP Switching: Features

- ❑ Runs as added software on an ATM switch
- ❑ Implemented by several vendors
- ❑ Multicast flows \Rightarrow pt-mpt VC per source
- ❑ Routing bypassed \Rightarrow Firewall bypassed
 - Solution: IP fields are deleted before segmentation and added after assembly \Rightarrow First packet has to go through firewall.
- ❑ Initially IP only. IPX supported via tunneling in IP.

Raj Jain

82

Epsilon's IP Switching: Issues

- ❑ VCI field is used as ID.
VPI/VCI change at switch
⇒ Must run on **every** ATM switch
⇒ non-IP switches not allowed between IP switches
⇒ Subnets limited to one switch
- ❑ Cannot support VLANs
- ❑ Scalability: Number of VC \geq Number of flows.
⇒ **VC Explosion.** 1000 setups/sec.
- ❑ Quality of service determined implicitly by the flow class or by RSVP
- ❑ ATM Only

Raj Jain

83

Tag Switching

- ❑ Proposed by CISCO
- ❑ Similar to VLAN tags
- ❑ Tags can be explicit or implicit L2 header



- ❑ Ingress router/host puts a tag. Exit router strips it off.

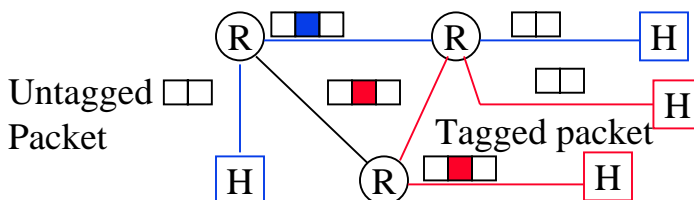

Raj Jain

84

Tag Switching (Cont)

- ❑ Switches switch packets based on labels.
Do not need to look inside \Rightarrow Fast.
- ❑ One memory reference compared to 4-16 in router
- ❑ Tags have local significance
 \Rightarrow Different tag at each hop (similar to VC #)

Raj Jain

85

Tag Switching (Cont)

- ❑ One VC per routing table entry

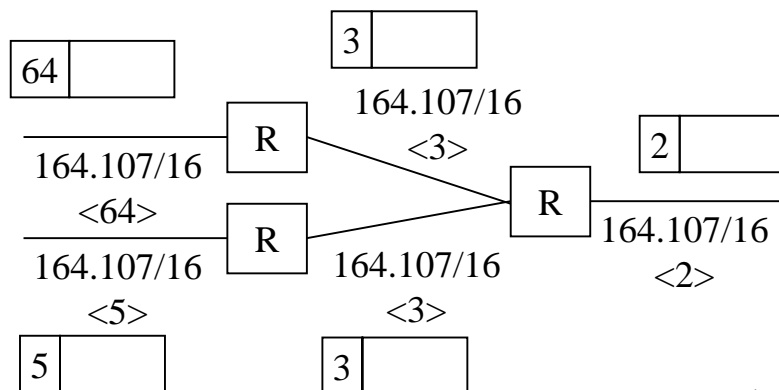

Raj Jain

86

Alphabet Soup

- ❑ CSR Cell Switched Router
- ❑ ISR Integrated Switch and Router
- ❑ LSR Label Switching Router
- ❑ TSR Tag Switching Router
- ❑ Multi layer switches, Swoters
- ❑ DirectIP
- ❑ FastIP
- ❑ PowerIP

Raj Jain

87

MPLS

- ❑ Multiprotocol Label Switching
- ❑ IETF working group to develop switched IP forwarding
- ❑ Initially focused on IPv4 and IPv6.
Technology extendible to other L3 protocols.
- ❑ Not specific to ATM. ATM or LAN.
- ❑ Not specific to a routing protocol (OSPF, RIP, ...)
- ❑ Optimization only. Labels do not affect the path.
Only speed. Networks continue to work w/o labels

Raj Jain

88

Label Assignment

- ❑ Binding between a label and a route
- ❑ Traffic, topology, or reservation driven
- ❑ Traffic: Initiated by upstream/downstream/both
- ❑ Topology: One per route, one per MPLS egress node.
- ❑ Labels may be preassigned
⇒ first packet can be switched immediately
- ❑ Reservations: Labels assigned when RSVP “RESV” messages sent/received.
- ❑ Unused labels are "garbage collected"
- ❑ Labels may be shared, e.g., in some multicasts

Raj Jain

89

Label Format

- ❑ Labels = Explicit or implicit L2 header
- ❑ TTL = Time to live
- ❑ CoS = Class of service
- ❑ SI = Stack indicator

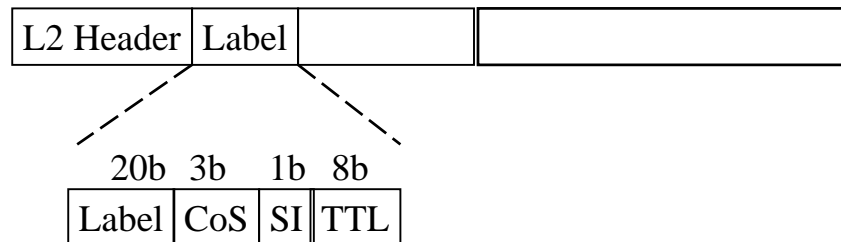

Raj Jain

90

Label Stacks

- ❑ Labels are pushed/popped as they enter/leave MPLS domain
- ❑ Routers in the interior will use Interior Gateway Protocol (IGP) labels. Border gateway protocol (BGP) labels outside.

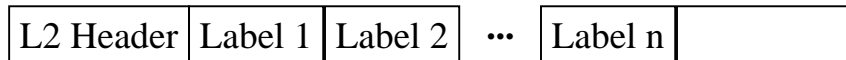

Raj Jain

91

MPLS: Issues

- ❑ Loop prevention, detection, survival
- ❑ Multicast:
Multiple entries in label information base
- ❑ Multipath: Streams going to the same destination but different sources/port # may be assigned separate labels.
- ❑ Host involvement: Label-enabled hosts will avoid first hop reassembly
- ❑ Security: Label swapping may be terminated before firewall

Raj Jain

92

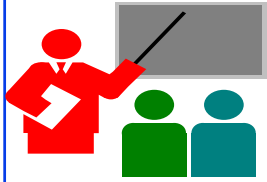

Summary

- ❑ LANE allows current applications to run on ATM
- ❑ Classical IP allows ARP using ATMARP servers
- ❑ NHRP removes the need for routing in an ATM net
- ❑ MPOA combines LANE and NHRP
- ❑ IP Switching: Traffic-based, per-hop VCs, downstream originated
- ❑ Tag switching: Topology based, one VC per route
- ❑ MPLS combines various features of IP switching, CSR, Tag switching, ARIS

Raj Jain

93

Summary (Cont)

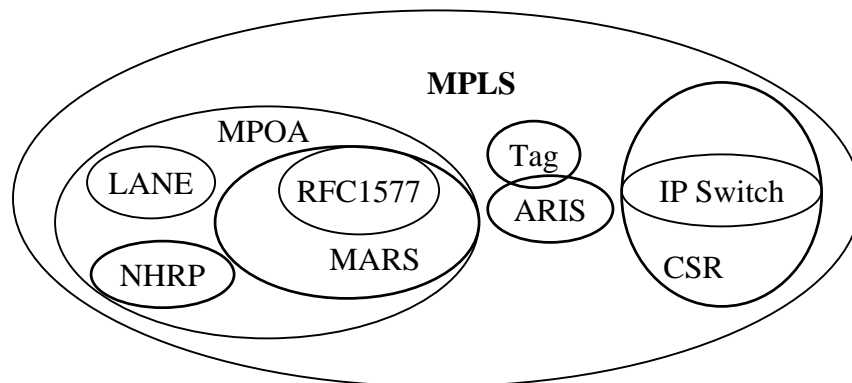

Raj Jain

94

Key References

- ❑ See http://www.cis.ohio-state.edu/~jain/refs/ipoa_ref.htm and http://www.cis.ohio-state.edu/~jain/refs/ipsw_ref.htm
- ❑ "A Framework for Multiprotocol Label Switching", 11/26/1997, <http://www.internic.net/internet-drafts/draft-ietf-mpls-framework-02.txt>
- ❑ Multiprotocol Label Switching (mpls) working group at IETF. Email: mpls-request@cisco.com

Raj Jain

95

References (Cont)

- ❑ ATM Forum, "MPOA V1.0," July 1997, <ftp://ftp.atmforum.com/pub/approved-specs/af-mpoa-0087.000.doc>
- ❑ RFC 2332, "NBMA Next Hop Resolution Protocol (NHRP)", <ftp://ftp.isi.edu/in-notes/rfc2322.txt> , 2/6/98.
- ❑ RFC 2225, "Classical IP and ARP over ATM," 1/20/94, <ftp://ftp.isi.edu/in-notes/rfc2225.txt>
- ❑ LAN Emulation over ATM v1.0 Specification (Jan 1995), <ftp://ftp.atmforum.com/pub/approved-specs/af-lane-0021.000.ps>

Raj Jain

96



97

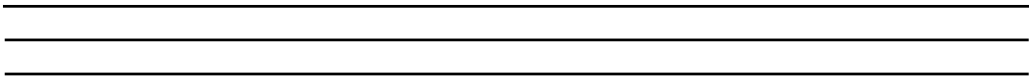

98

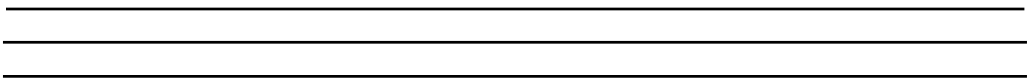

Gigabit Ethernet

Raj Jain
Professor of Computer and Information Sciences
The Ohio State University
Columbus, OH 43210
<http://www.cis.ohio-state.edu/~jain/>

Raj Jain

99



- Distance-Bandwidth Principle
- 10 Mbps to 100 Mbps
- Gigabit PHY and MAC Issues
- ATM vs Gigabit Ethernet
- 1000BASE-T for 1 Gbps over UTP5
- Link aggregation

Raj Jain

100

Distance-B/W Principle

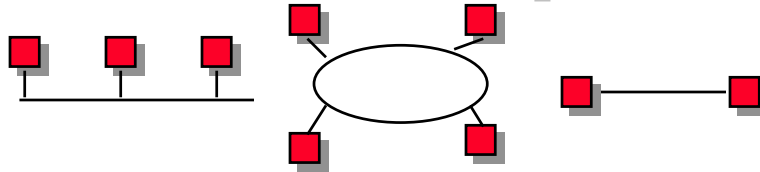

- Efficiency = Max throughput/Media bandwidth
- Efficiency is a nonincreasing function of α
 - α = Propagation delay /Transmission time
 - = (Distance/Speed of light)/(Transmission size/Bits/sec)
 - = Distance×Bits/sec/(Speed of light)(Transmission size)
- Bit rate-distance-transmission size tradeoff.
- 100 Mb/s \Rightarrow Change distance or frame size

Raj Jain

102

Ethernet vs Fast Ethernet

	Ethernet	Fast Ethernet
Speed	10 Mbps	100 Mbps
MAC	CSMA/CD	CSMA/CD
Network diameter	2.5 km	205 m
Topology	Bus, star	Star
Cable	Coax, UTP, Fiber	UTP, Fiber
Standard	802.3	802.3u
Cost	X	2X

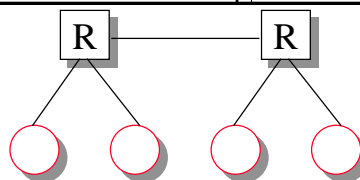

Raj Jain

104

Fast Ethernet Standards

- ❑ **100BASE-T4:** 100 Mb/s over 4 pairs of CAT-3, 4, 5
- ❑ **100BASE-TX:** 100 Mb/s over 2 pairs of CAT-5, STP
- ❑ **100BASE-FX:** 100 Mbps CSMA/CD over 2 fibers
- ❑ **100BASE-X:** 100BASE-TX or 100BASE-FX
- ❑ **100BASE-T:** 100BASE-T4, 100BASE-TX, or 100BASE-FX

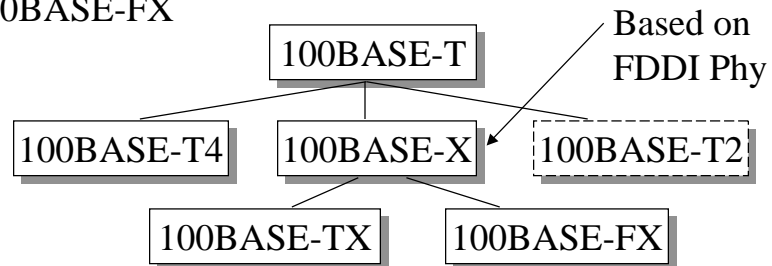

Raj Jain

105

100 BASE-X

- ❑ X = Cross between IEEE 802.3 and ANSI X3T9.5

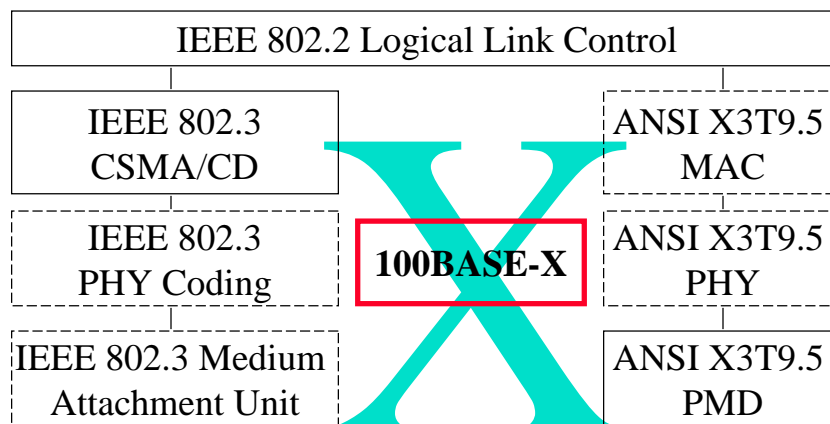

Raj Jain

106

Full-Duplex Ethernet

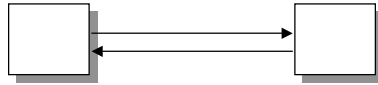

- ❑ Uses point-to-point links between **TWO** nodes
- ❑ Full-duplex bi-directional transmission
- ❑ Transmit any time
- ❑ Many vendors are shipping switch/bridge/NICs with full duplex
- ❑ No collisions \Rightarrow 50+ Km on fiber.
- ❑ Between servers and switches or between switches

Raj Jain

107

Gigabit Ethernet

- ❑ Being standardized by 802.3z
- ❑ Project approved by IEEE in June 1996
- ❑ 802.3 meets every three months \Rightarrow Too slow
 \Rightarrow Gigabit Ethernet Alliance (GEA) formed.
It meets every two weeks.
- ❑ Decisions made at GEA are formalized at 802.3 High-Speed Study Group (HSSG)
- ❑ Based on Fiber Channel PHY
- ❑ Shared (half-duplex) and full-duplex version
- ❑ Gigabit 802.12 and 802.3 to have the same PHY

Raj Jain

108

How Much is a Gbps?

- ❑ 622,000,000 bps = OC-12
- ❑ 800,000,000 bps (100 MBps Fiber Channel)
- ❑ 1,000,000,000 bps
- ❑ 1,073,741,800 bps = 2^{30} bps ($2^{10} = 1024 = 1k$)
- ❑ 1,244,000,000 bps = OC-24
- ❑ 800 Mbps \Rightarrow Fiber Channel PHY
 \Rightarrow Shorter time to market
- ❑ Decision: 1,000,000,000 bps \Rightarrow 1.25 GBaud PHY
- ❑ Not multiple speed \Rightarrow Sub-gigabit Ethernet rejected
- ❑ 1000Base-X

Raj Jain

109

Physical Media

- ❑ Unshielded Twisted Pair (UTP-5): 4-pairs
- ❑ Shielded Twisted Pair (STP)
- ❑ Multimode Fiber: 50 μ m and 62.5 μ m
 - Use CD lasers
- ❑ Single-Mode Fiber
- ❑ Bit Error Rate better than 10^{-12}

Raj Jain

110

How Far Should It Go?

- Full-Duplex:
 - Fiber Channel: 300 m on 62.5 μm at 800 Mbps \Rightarrow 230 m at 1000 Mbps
 - Decision: 500 m at 1000 Mbps \Rightarrow Minor changes to FC PHY
- Shared:
 - CSMA/CD without any changes \Rightarrow 20 m at 1 Gb/s (Too small)
 - Decision: 200 m shared \Rightarrow Minor changes to 802.3 MAC

Raj Jain

111

PHY Issues

- Fiber Channel PHY:
 - 100 MBps = 800 Mbps
 - \Rightarrow 1.063 GBaud using 8b10b
- Changes to get 500 m on 62.5- μm multimode fiber
 - Modest decrease in rise and fall times of the transceivers

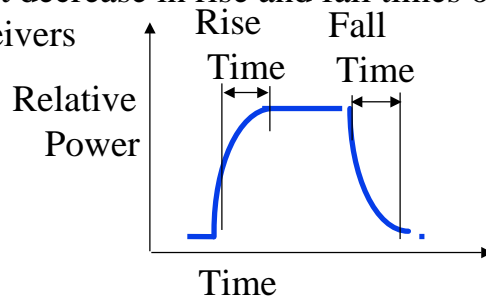

Raj Jain

112

- ❑ Symbol Codes for Specific Signals: Jam, End-of-packet, beginning of packet
- ❑ PHY-based flow Control: No.
Use the XON/XOFF flow control of 802.3x

Raj Jain

113

850 nm vs 1300 nm lasers

- ❑ 850 nm used in 10Base-F
 - Cannot go full distance with 62.5- μ m fiber
 - 500 m with 50- μ m fiber
 - 250 m with 62.5- μ m fiber
- ❑ 1300 nm used in FDDI but more expensive
 - Higher eye safety limits
 - Better Reliability
 - Start with 550 m on 62.5- μ m fiber
 - Could be improved to 2 km on 62.5- μ m fiber
 - ⇒ Needed for campus backbone

Raj Jain

114

Media Access Control Issues

- ❑ Carrier Extension
- ❑ Frame Bursting
- ❑ Buffered Distributor

Raj Jain

115

Carrier Extension

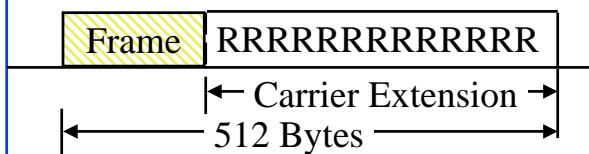

- ❑ 10 Mbps at 2.5 km \Rightarrow Slot time = 64 bytes
- ❑ 1 Gbps at 200 m \Rightarrow Slot time = 512 bytes
- ❑ Continue transmitting control symbols.
Collision window includes the control symbols
- ❑ Control symbols are discarded at the destination
- ❑ Net throughput for small frames is only marginally better than 100 Mbps

Raj Jain

116

Frame Bursting

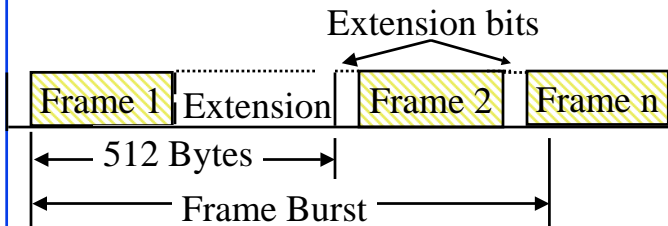

- ❑ Don't give up the channel after every frame
- ❑ After the slot time, continue transmitting additional frames (with minimum inter-frame gap)
- ❑ Interframe gaps are filled with extension bits
- ❑ No no new frame transmissions after 8192 bytes
- ❑ Three times more throughput for small frames

Raj Jain

117

Buffered Distributor

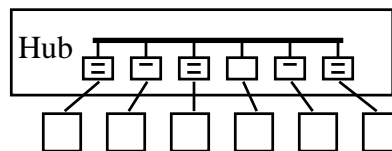

- ❑ All incoming frames are buffered in FIFOs
- ❑ CSMA/CD arbitration inside the box to transfer frames from an incoming FIFO to all outgoing FIFOs
- ❑ Previous slides were half-duplex. With buffered distributor all links are full-duplex with frame-based flow control
- ❑ Link length limited by physical considerations only

Raj Jain

118

Schedule

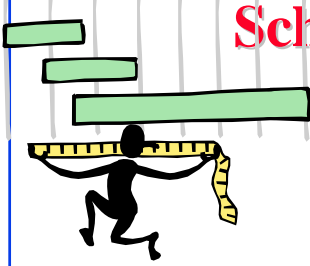

- ❑ November 1996: Proposal cutoff
- ❑ July 1997: Working Group Ballot
- ❑ March 1998: Approval
- ❑ Status: Approved in July 1998.

Raj Jain

119

1000Base-X

- ❑ 1000Base-LX: 1300-nm laser transceivers
 - 2 to 550 m on 62.5- μm or 50- μm multimode, 2 to 3000 m on 10- μm single-mode
- ❑ 1000Base-SX: 850-nm laser transceivers
 - 2 to 300 m on 62.5- μm , 2 to 550 m on 50- μm . Both multimode.
- ❑ 1000Base-CX: Short-haul copper jumpers
 - 25 m 2-pair shielded twinax cable in a single room or rack.
 - Uses 8b/10b coding \Rightarrow 1.25 Gbps line rate

Raj Jain

120

1000Base-T

- ❑ 100 m on 4-pair Cat-5 UTP
⇒ Network diameter of 200 m
- ❑ 250 Mbps/pair full duplex DSP based PHY
⇒ Requires new 5-level (PAM-5) signaling with 4-D 8-state Trellis code FEC
- ❑ Automatically detects and corrects pair-swapping, incorrect polarity, differential delay variations across pairs
- ❑ Autonegotiation ⇒ Compatibility with 100Base-T
- ❑ 802.3ab task force began March'97, ballot July'98, Final standard by March'99.

Raj Jain

121

Link Aggregation

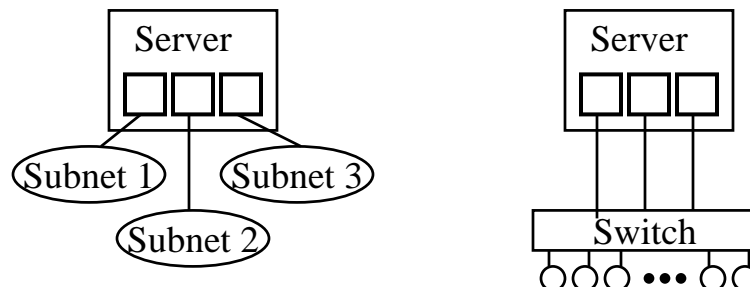

- ❑ Server needs only one IP and MAC address.
- ❑ Incremental bandwidth
- ❑ More reliability. More flexibility in bandwidth usage
- ❑ Issues: Configuration error detection
- ❑ 802.3ad task force PAR approved July 1998.

Raj Jain

122

Design Parameter Summary

Parameter	10 Mbps	100 Mbps	1 Gbps
Slot time	512 bt	512 bt	4096 bt
Inter Frame Gap	9.6 μ s	0.96 μ s	0.096 μ s
Jam Size	32 bits	32 bits	32 bits
Max Frame Size	1518 B	1518 B	1518 B
Min Frame Size	64 B	64 B	64 B
Burst Limit	N/A	N/A	8192 B

□ bt = bit time

Raj Jain

123

ATM vs Gb Ethernet

Issue	ATM	Gigabit Ethernet
Media	SM Fiber, MM Fiber, UTP5	Mostly fiber
Max Distance	Many miles using SONET	260-550 m
Data Applications	Need LANE, IPOA	No changes needed
Interoperability	Good	Limited
Ease of Mgmt	LANE	802.1Q VLANs
QoS	PNNI	802.1p (Priority)
Signaling	UNI	None/RSVP (?)
Traffic Mgmt	Sophisticated	802.3x Xon/Xoff

Raj Jain

124

Summary

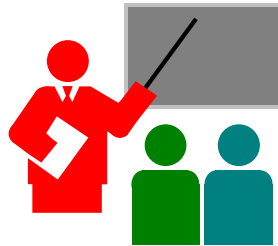

- ❑ Gigabit Ethernet runs at 1000 Mbps
- ❑ Both shared and full-duplex links
- ❑ Fully compatible with current Ethernet
- ❑ 1000BASE-T allows 1000 Mbps over 100m of UTP4
- ❑ Link aggregation will allow multiple links in parallel

Raj Jain

125

References

- ❑ For a detailed list of references, see http://www.cis.ohio-state.edu/~jain/refs/gbe_refs.htm
- ❑ Gigabit Ethernet Overview, http://www.cis.ohio-state.edu/~jain/cis788-97/gigabit_ethernet/index.htm
- ❑ "100BASE-X: MAC, PHY, Repeater, and Management Parameters for 1000 Mb/s Operation," IEEE 802.3z, June 25, 1998.
- ❑ IEEE 802.3z Gigabit Task force, <http://grouper.ieee.org/groups/802/3/z/index.html>
- ❑ Gigabit Ethernet Consortium <http://www.gigabit-ethernet.org>

Raj Jain

126



127

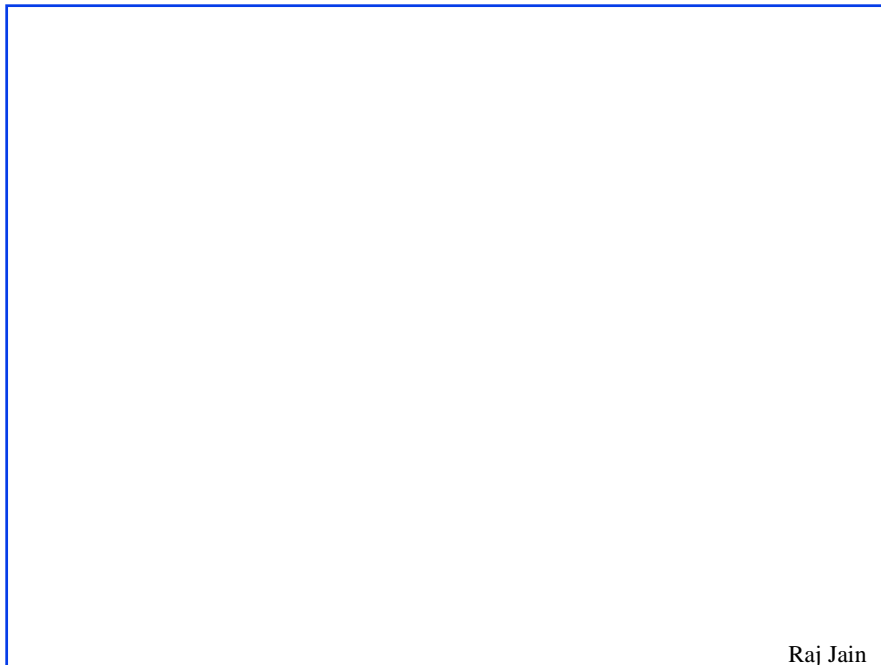
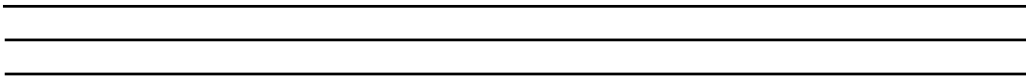

128

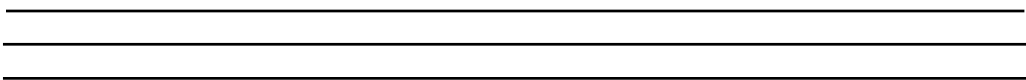

Final Review: 13 Hot Facts

1. Networking is critical and growing exponentially.
2. Networking is the key to productivity
3. LAN Emulation allows current LAN applications to run on ATM
4. Classical IP allows address resolution using LIS servers
5. NHRP allows shortcuts between ATM hosts
6. MARS allows multicast address resolution.

Raj Jain

129

Final Review (Cont)

7. MPOA combines LANE, NHRP, and MARS and reduces the need for routers
8. IP switching allows some IP packets to go through an ATM network without reassembly at intermediate routers.
9. To succeed, ATM has to solve today's problem (data) at a price competitive to LANs.
10. 100 Mbps Ethernet limited to 200 m to desktop. Not limited in full-duplex mode.
11. Gigabit Ethernet will compete with ATM for campus backbone and desktop

Raj Jain

130

Final Review (Cont)

12. Gigabit Ethernet will support both shared and full-duplex links
13. Most gigabit Ethernet links will be full-duplex

Raj Jain