

# Virtual LANs

Raj Jain

Professor of Computer and Information Sciences

The Ohio State University

Please download and print the handouts from:

<http://www.cis.ohio-state.edu/~jain/cis788-97/>

or

<http://www.netlab.ohio-state.edu/~jain/cis788-97/>

# MBone Instructions

- ❑ Handouts for the class are available on-line:  
<http://www.cis.ohio-state.edu/~jain/cis788-97/index.html> or  
<http://www.netlab.ohio-state.edu/~jain/cis788-97/index.html> or  
<ftp://netlab.ohio-state.edu/pub/jain/cis788-97/>
- ❑ The schedule keeps changing. Please always check current schedule at:  
<http://www.cis.ohio-state.edu/~jain/cis788-97/schedule.html>

# Instructions (Cont)

- ❑ Please email your positive and negative feedback about the quality of the reception as well as the content with a subject field of “**Feedback**” to [mbone@netlab.ohio-state.edu](mailto:mbone@netlab.ohio-state.edu)
- ❑ If you are not able to receive the program due to some technical difficulties, please email “**Feedback**” to [mbone@netlab.ohio-state.edu](mailto:mbone@netlab.ohio-state.edu)
- ❑ Please email technical questions with the subject field “**Question**” to [mbone@netlab.ohio-state.edu](mailto:mbone@netlab.ohio-state.edu). We will try to answer selected questions live.



- ❑ What is a LAN and what is a Virtual LAN?
- ❑ Types of Virtual LANs
- ❑ IEEE 802.1Q standard

# What is a LAN?

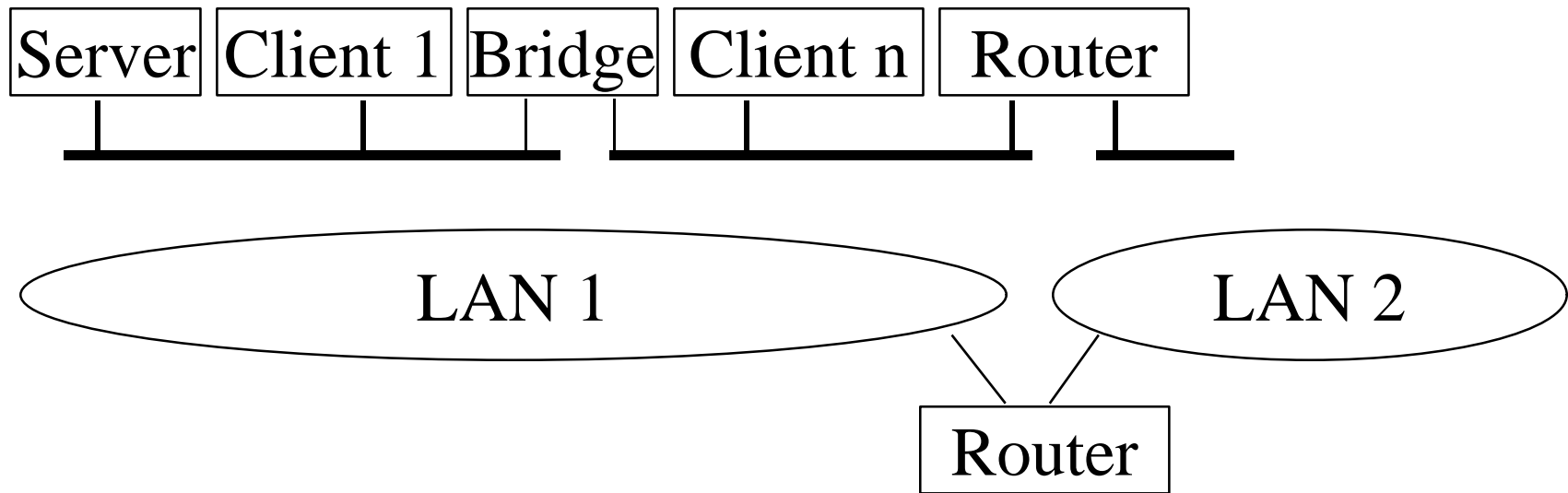

- ❑ LAN = Single broadcast domain = Subnet
- ❑ No routing between members of a LAN
- ❑ Routing required between LANs

# What is a Virtual LAN

## Physical View

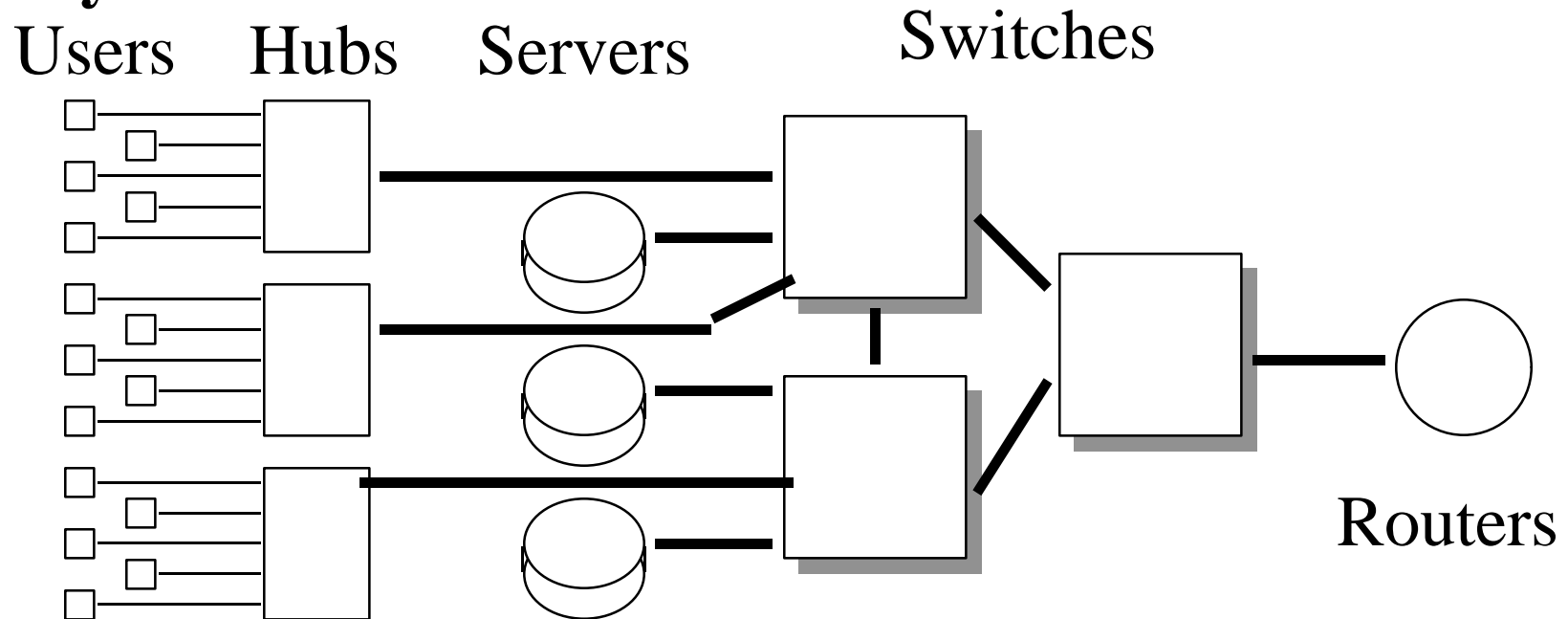

## Logical View

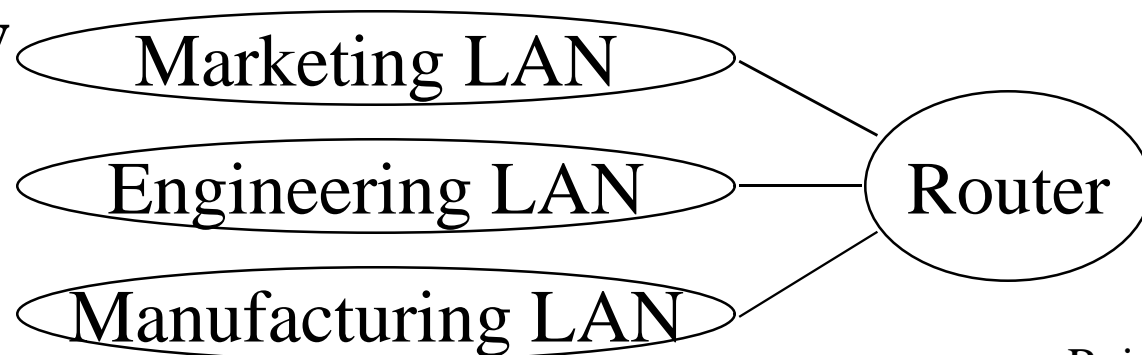

# Virtual LAN

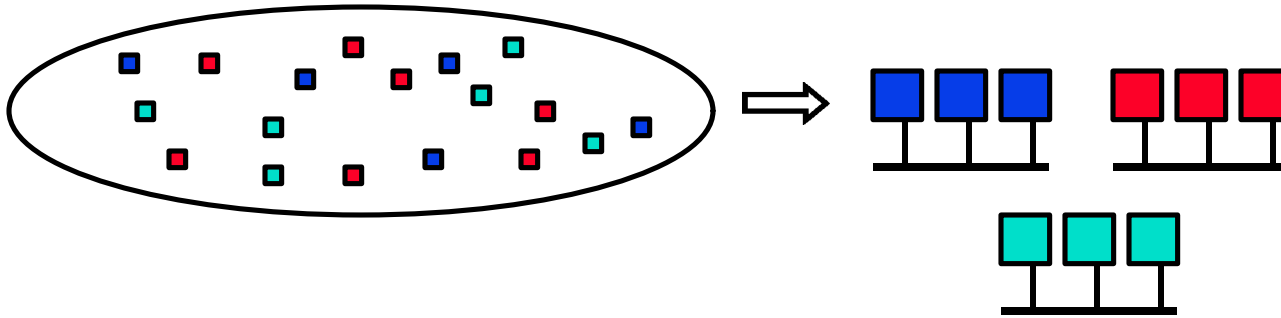

- ❑ Virtual LAN = Broadcasts and multicast goes only to the nodes in the virtual LAN
- ❑ LAN membership defined by the network manager  
⇒ Virtual

# VLAN: Why?

- Virtual is Better than Real
  - Location-independent
    - ⇒ Marketing LAN can be all over the building
  - Users can move but not change LAN
  - Traffic between LANs is routed
    - ⇒ Better to keep all traffic on one LAN
  - Switch when you can, route when you must
    - ⇒ Do not VLAN over expensive WAN links
  - Better security

# Types of Virtual LANs

- Layer-1 VLAN = Group of Physical ports
- Layer-2 VLAN = Group of MAC addresses
- Layer-3 VLAN = IP subnet

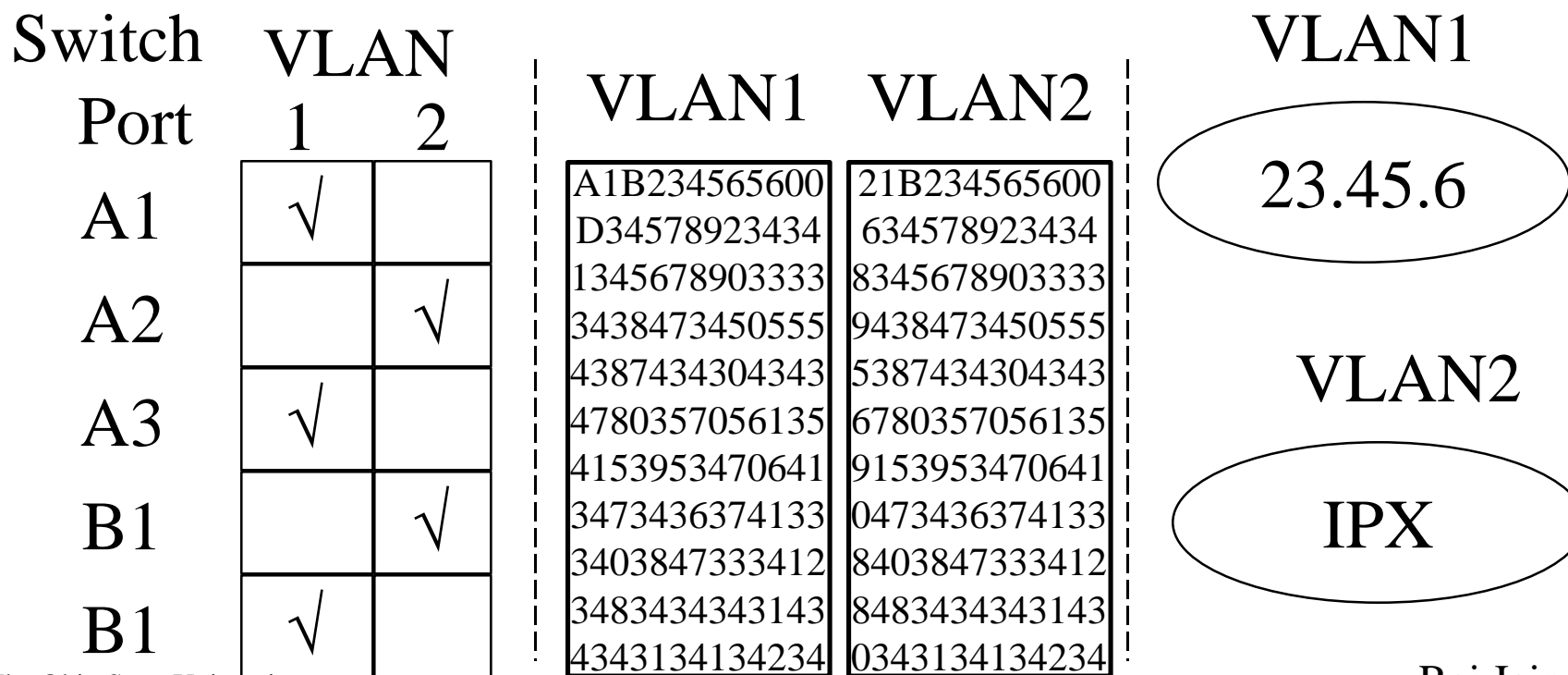



# Layer-2 VLANs

- ❑ LANs defined by a list of MAC addresses
- ❑ Provides full user movement
- ❑ Clients and server always on the same LAN regardless of location
- ❑ Problem: Too many addresses need to be entered and managed

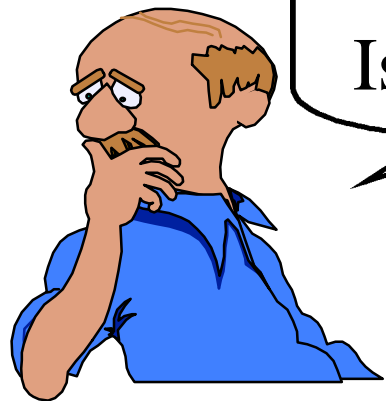

0234786890  
Is that a marketing node?

# Layer-2 VLANs (Cont)

- Notebook PCs change docking stations  
⇒ MAC address changes
- Alternative: Membership implied by MAC protocol type field. VLAN1 = IP, VLAN2 = LAT, ...

## Ethernet



## 802.3

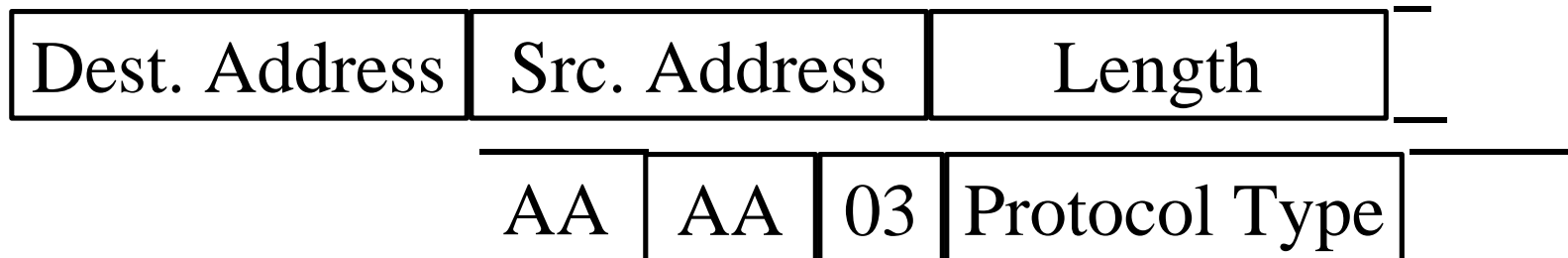

# Layer-3 VLANs

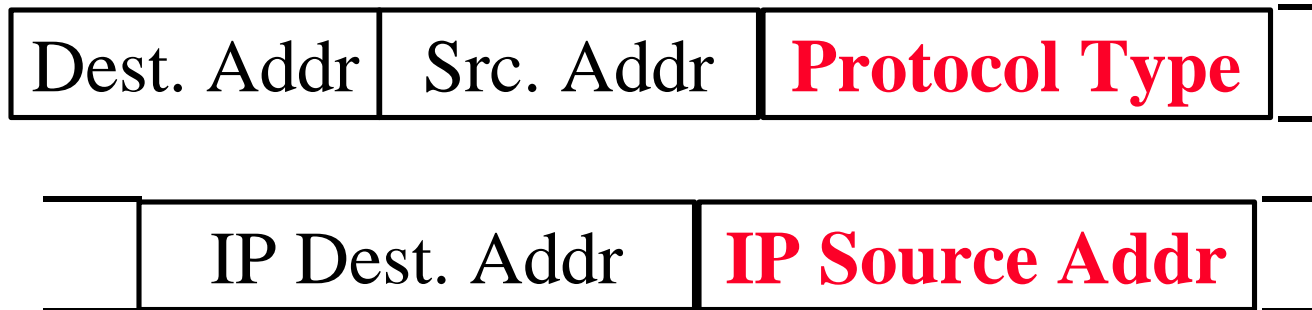

- ❑ Also known as virtual subnet
- ❑ VLAN membership implied by MAC-layer protocol type field and subnet field 123.34.\*.\*
- ❑ VLAN configuration is learned by the switches
- ❑ Stations do not belong to VLANs, packets do.
- ❑ Multiprotocol stations are put into multiple VLANs

# Higher Layer VLANs

- ❑ Different VLANs for different applications:
  - FTP
  - Multimedia
- ❑ Service based VLANs: All workstations using Email server are on the EMAIL-VLAN, all workstations using employee database sever are on the HR-VLAN,..
- ❑ IP Multicast address based VLANs
- ❑ General policy based: VLAN membership can be based on a combination of incoming port, MAC address, subnet, or higher layer info, time of day.

# VLAN Tagging

Dest. Addr	Src. Addr	VLAN Tag	Prot. Type
------------	-----------	----------	------------

- ❑ First switch adds tag containing VLAN id to all incoming packets
- ❑ Intermediate switches do not recompute the VLAN id
- ❑ Last switch removes tags from all outgoing packets
- ❑ Tag is not swapped at every hop like VC Id or labels

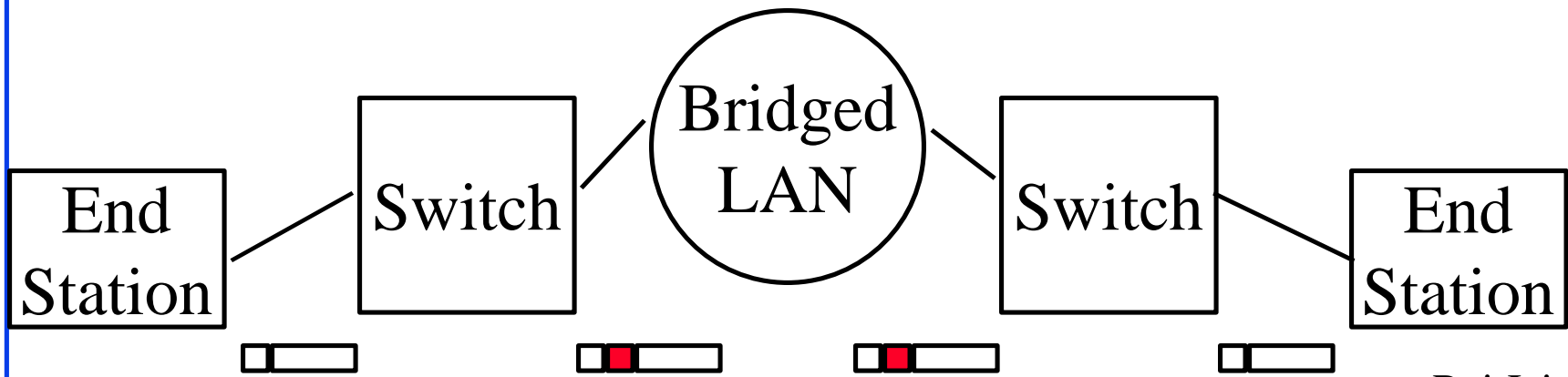

# Synonyms

- Tag
- Label
- Mark
- Sticker
- Brand

# IEEE 802.1Q: Features

- ❑ Allows up to 4095 VLANs
- ❑ Allows port based, MAC address based, and higher-layer VLANs
- ❑ Upward compatible with existing VLAN-unaware hubs and bridges
- ❑ Supports both shared-media and switched LANs
- ❑ Allows mixing legacy bridges and VLAN-aware bridges
- ❑ Retains plug and play mode of current LAN bridges

# Features (Cont)

- ❑ Extends 802.1p priority mechanism to priority based on VLAN membership
- ❑ Allows priority associated with each VLAN
- ❑ VLAN-based priority takes precedence over other priority considerations
- ❑ Allows signaling priority information on non-priority (CSMA/CD) LANs
- ❑ Allows both local/universal MAC addresses
- ❑ Operation with/without explicit VLAN header in the frame

# Features (Cont)

- ❑ Supports static and dynamic configurations for each VLAN
- ❑ Allows intermixing different IEEE 802 MACs and FDDI
- ❑ Allows signaling source routing information on CSMA/CD LANs
- ❑ Each VLAN is a subset of a "single" physical spanning tree  
Does not preclude future extensions to multiple spanning trees

# Features (Cont)

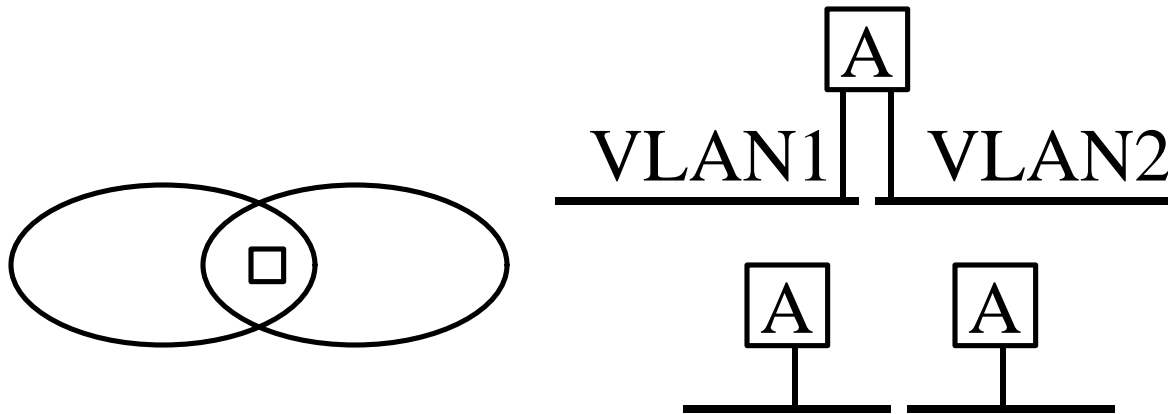

## ❑ Overlapping VLANs:

- Multiple stations with same individual address
- One station with multiple interfaces using the same address
- Restriction: One station or interface per VLAN

# Tagging Rules

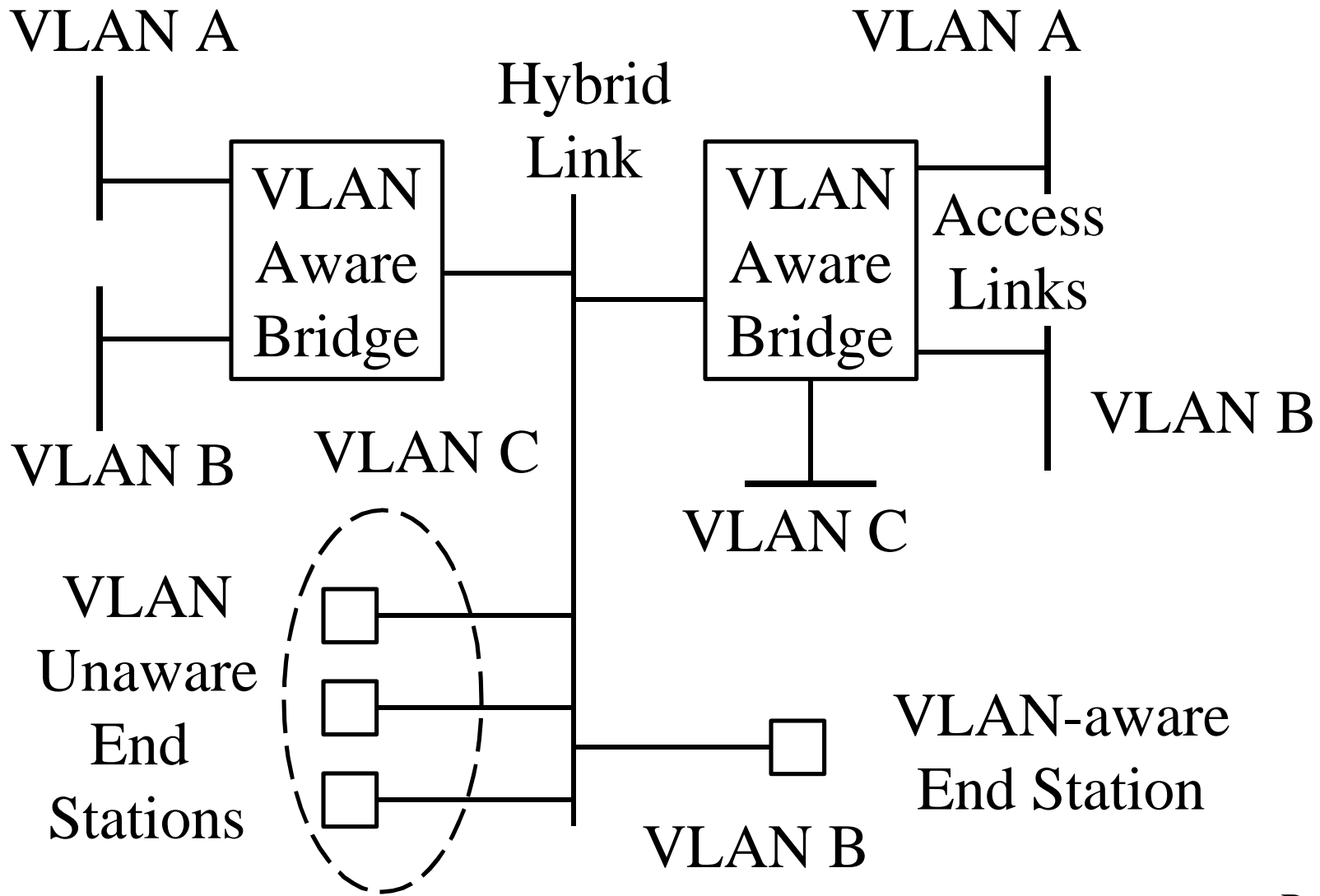

# Tagging Rules (Cont)

- ❑ On a given LAN segment for a given VLAN, all frames should be either implicitly or explicitly tagged.
- ❑ Different VLANs on the same segment may use different options.
- ❑ Access Link: Contain VLAN unaware devices  
All frames on access links are untagged
- ❑ Hybrid Link: Contains both VLAN-aware and VLAN-unaware devices
  - All frames for some VLANs are tagged
  - All frames for other VLANs are untagged

# Tagged Frame Format

## □ Tag Header:



## □ Ethernet Frame:

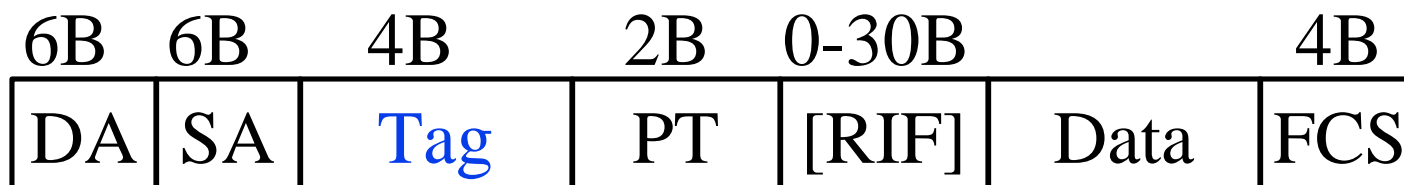

## □ 802.3 Frame:

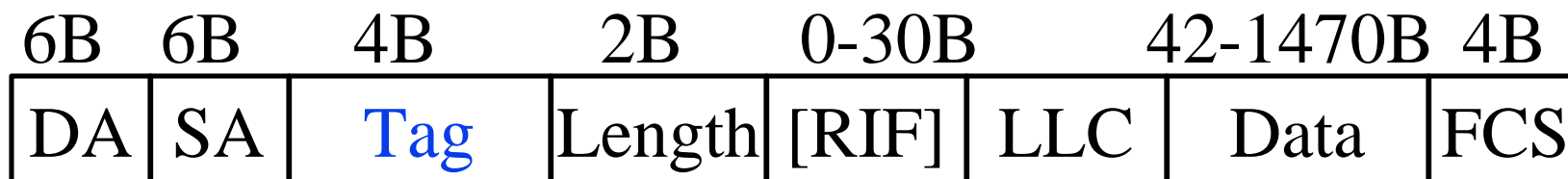

# Frame Format (Cont)

- ❑ TPID = Tag Protocol ID
- ❑ CFI = Canonical Format Indicator
  - = Bit order of address info in TR/FDDI frames
  - = Presence/absence of RIF in 802.3/Ethernet frames
- ❑ RIF = Routing Information Field
  - New routing type: 01 = Transparent frame  
⇒ No routing info.
- ❑ DA = Destination Address, SA = Source Address  
PT = Protocol Type, LLC = Logical Link Control  
FCS = Frame Check Sequence
- ❑ Largest data size = 1470 on 802.3

# Frame Format (Cont)

## □ Token Ring:

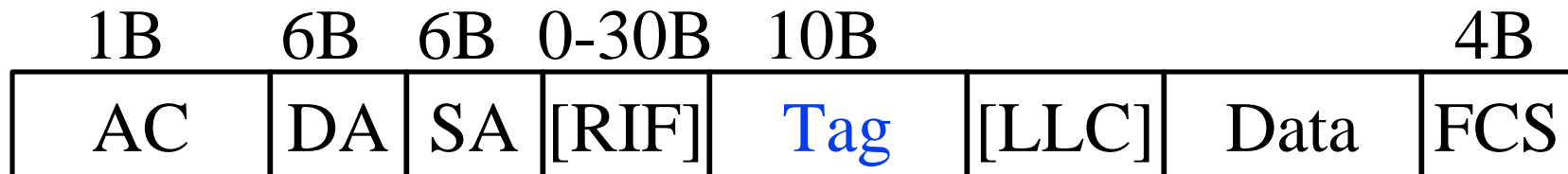

## □ FDDI:

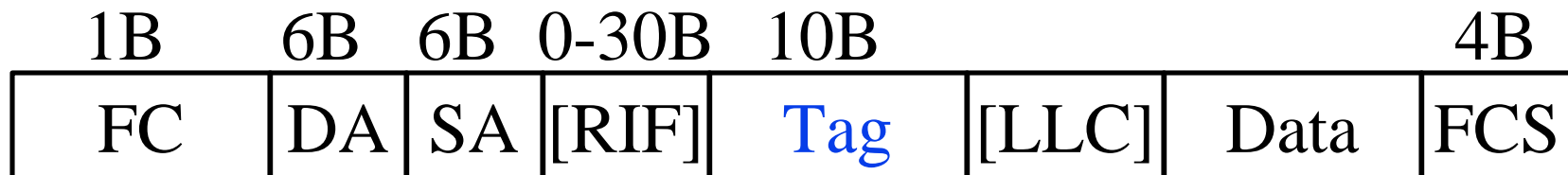

# GVRP

- ❑ GARP VLAN registration protocol
- ❑ GARP = Generic attribute registration protocol
- ❑ Register VLAN Ids and port filtering modes
- ❑ Both end-stations and bridges can be GARP participants
- ❑ GARP Participants issue/revoke membership declaration  $\Rightarrow$  Creates entries in the databases
- ❑ VLAN-aware bridges propagate VLAN membership changes on all active ports

# GVRP (Cont)

- ❑ VLAN-aware end stations can "source prune" traffic for VLANs that have no other members
- ❑ Initially, all ports on all bridges are set to a default "Port VLAN ID"

# GMRP in VLANs

- ❑ Original GMRP is designed for one LAN  
⇒ One one context or base spanning tree context
- ❑ With VLANs, multicast addresses are registered a particular VLAN context  
⇒ Filtering behavior in a VLAN does not affect other VLANs

# VLAN Filtering Database

- ❑ Two Types of Entries:
  - VLAN Registration entries
  - Group Registration entries
- ❑ Both types can static or dynamic
  - Static VLAN Entries: via Management
  - Dynamic Filtering Entry:
    - ❑ via learning or registration
    - ❑ Learnt entries are aged out
- ❑ Port Map for each VLAN: Whether frames should be tagged or untagged

# Communication Between VLANs

- ❑ Need routers
- ❑ Can use 1-armed VLAN-aware router
- ❑ VLAN-aware switches can route between VLANs
- ❑ Such switches can be placed in the core, in the edges, or everywhere

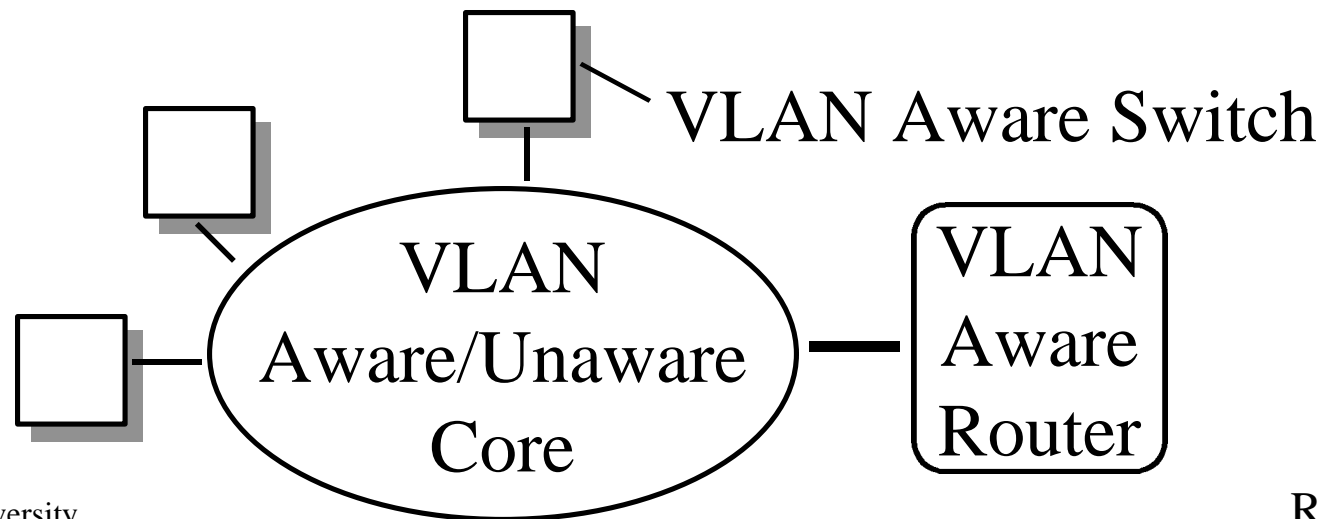

# Summary

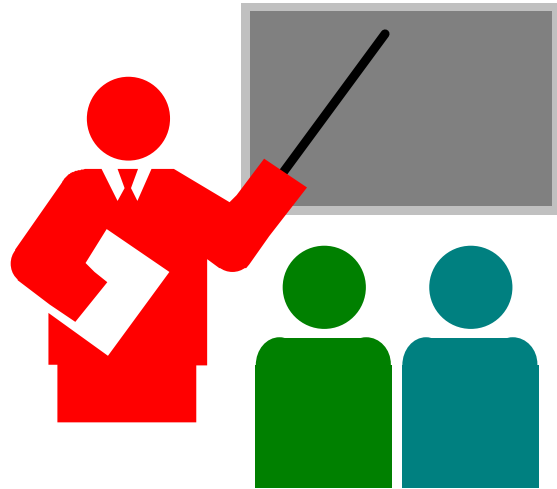

- ❑ Virtual LANs  $\Rightarrow$  Location independent LAN Groups
- ❑ Layer-1, Layer-2, Layer-3, higher layer VLANs
- ❑ IEEE 802.1Q allows both explicit and implicit tagging
- ❑ Need routing between VLANs

# References

- ❑ For a detailed list of references, see [http://www.cis.ohio-state.edu/~jain/refs/lsw\\_refs.htm](http://www.cis.ohio-state.edu/~jain/refs/lsw_refs.htm)
- ❑ Email list: [p8021-request@hepnrc.hep.net](mailto:p8021-request@hepnrc.hep.net)  
Mail archive: <http://www.hep.net/mail/p8021.html>
- ❑ Draft Standard for Virtual Local Area Networks, IEEE P802.1Q/D6, May 16, 1997.

# Other Related Standards

- Traffic Class Expediting and Dynamic Multicast Filtering, IEEE P802.1p/D6, April 28, 1997.
- 802.1D MAC bridges
- 802.1G Remote MAC Bridging
- 802.1H Ethernet V2.0 and 802 bridging

# Current Schedule

7/17/97 Priority and Multicasting on LANs

7/22/97 **No Class**

7/24/97 Virtual LANs

7/29/97 Gigabit Ethernet

**7/31/97 Quiz 2 (No MBone transmission)**

8/5/97 Residential broadband: Cable Modems, xDSL

8/7/97 Multimedia: Compression Standards

8/12/97 Multimedia over IP: RSVP, RTP

8/14/97 Wireless LANs and WANs

**8/19/97 Quiz 3 (No MBone transmission)**

# Credits

This MBone transmission was made possible by:

- ❑ Mark Fullmer, OSU/UTS
- ❑ Mike Iverson, OSU/UTS
- ❑ Mike Douglas, OSU/UTS
- ❑ Jayaraman Iyer, OSU/CIS
- ❑ Sohail Munir, OSU/CIS