

ATM Signaling

Raj Jain

Professor of Computer and Information Science

The Ohio State University

Columbus, OH 43210

Jain@CIS.Ohio-State.Edu

<http://www.cis.ohio-state.edu/~jain/>



- ❑ Call Endpoints: Address Formats
- ❑ Call setup/release
- ❑ Traffic Contract: Bandwidth, Quality of Service
- ❑ Signaling Mechanisms: Message formats

Signaling Standards

- ❑ Q.931 = Basic Call Control for ISDN
- ❑ Q.932 = Extends/uses Q.931 for supplementary services (call forwarding, etc)
- ❑ Q.933 = Q.931 Extension/subset for Frame-relay
- ❑ Digital Subscriber Signaling System 1 (DSS1)
= Call control signaling over the D channel
= Q.931 + Q.932 + lower layers
- ❑ Signaling System 7 (SS7) deals with inside the network while DSS1 deals with outside.
- ❑ Q.2931 = Q.93B = Basic Call Control for B-ISDN

Signaling Channels

- Reserved VPI/VCI
 - x/1 = Meta-signaling
 - x/2 = Broadcast signaling (not used initially)
 - 0/5 = ATM endpoint to local network signaling
both point-to-point and point-to-multipoint signaling
 - x/5 = point-to-point signaling with other endpoints and other networks

Meta-Signaling

- ❑ Used to setup signaling channels
- ❑ All meta-signaling messages are one cell long and have VPI/VCI = 0/1
- ❑ Sets up 3 types of signaling channels:
 - Point-to-point
 - General broadcast
 - Selective broadcast
- ❑ Procedures to:
 - Set up new signaling channels
 - Release channels
 - Verify channels

ATM Addresses

- ATM Forum specifies three NSAP-like address formats: DCC ATM Format, ICD ATM Format, E.164 ATM Format. NSAP = Network Service Access Point

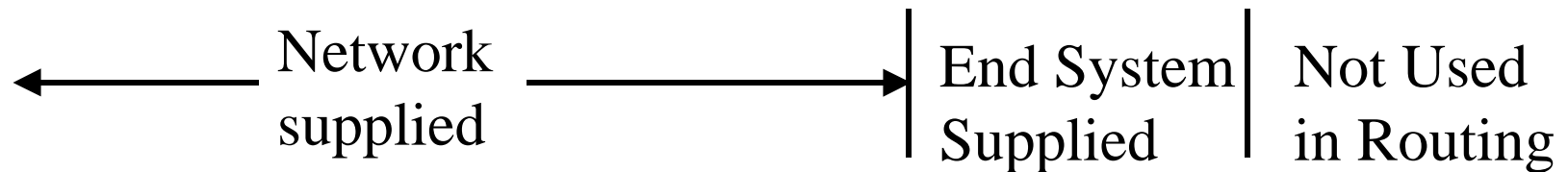

39	Data Country Code (2B)	High-Order DSP (10B)	End System ID (6B)	Selector (1B)
----	------------------------	----------------------	--------------------	---------------

47	International Code Designator (2B)	High-Order DSP (10B)	End System ID (6B)	Selector (1B)
----	------------------------------------	----------------------	--------------------	---------------

45	E.164 Number (8 B)	High-Order DSP (4B)	End System ID (6B)	Selector (1B)
----	--------------------	---------------------	--------------------	---------------



Addressing

- ❑ Authority and Format Identifier (AFI)
39 = ISO DCC, 47 = British Standards Institute
ICD, 45 = ITU ISDN
- ❑ Initial Domain Identifier (IDI). Domain Specific Part (DSP)
- ❑ ISDN uses E.164 numbers (up to 15 BCD digits)
- ❑ ATM forum extended E.164 addresses to NSAP format. E.164 number is filled with leading zeros to make 15 digits. A F_{16} is padded to make 8 bytes. AFI and DSP are added.

Addressing (Cont)

- ❑ End System Identifier (ESI): 48-bit IEEE MAC address.
- ❑ Selector is for use inside the host and is not used for routing.
- ❑ All ATM addresses are 20 bytes long.
- ❑ ATM forum removed the division of DSP into areas, etc.
- ❑ Private networks must support all three formats
Type of Number field = Unknown
Numbering Plan Indication field = ISO NSAP

Addressing (Cont)

- ❑ Public networks must support native E.164 and may optionally support three NSAP-encoded formats. For E.164:
Type of Number field = International number
Numbering Plan Indication field = Recommendation E.164
- ❑ If only native E.164 addresses, subaddress field in signaling messages used to convey private ATM address across.
- ❑ One Transit network selection possible using carrier identification code field.

NSAP is a Misnomer!

- ❑ NSAP = Network Service Access Point. Identifies network layer service entry
- ❑ SNPA = Subnetwork point of attachment. Identifies the interface to subnetwork
- ❑ SNPA address (or part of it) is used to carry the packet across the network.
- ❑ CLNP uses NSAP to deliver the packet to the right entity in the host.
- ❑ ATM uses NSAP-like encoding but ATM addresses identify SNPA and not NSAP.

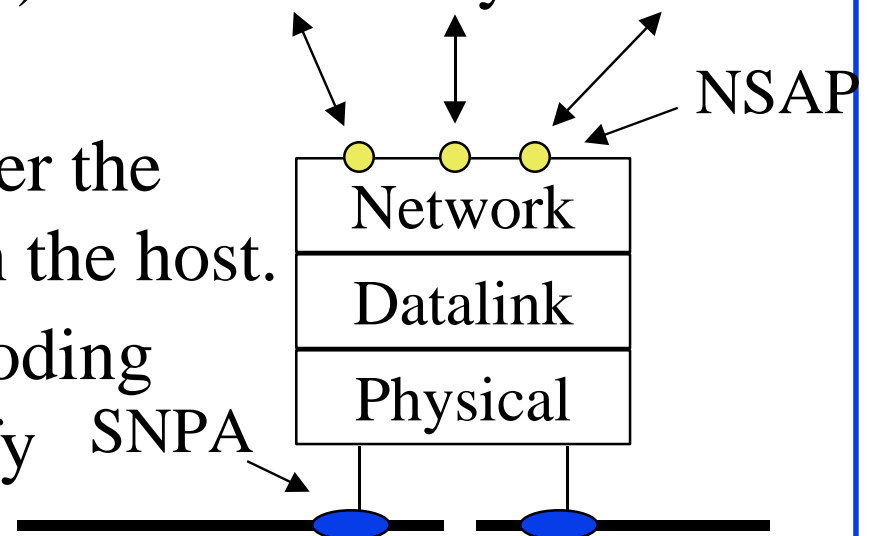

Address Registration

- User and switch register addresses using Interim Local Management Interface (ILMI)
= Simple Network Management Protocol (SNMP)

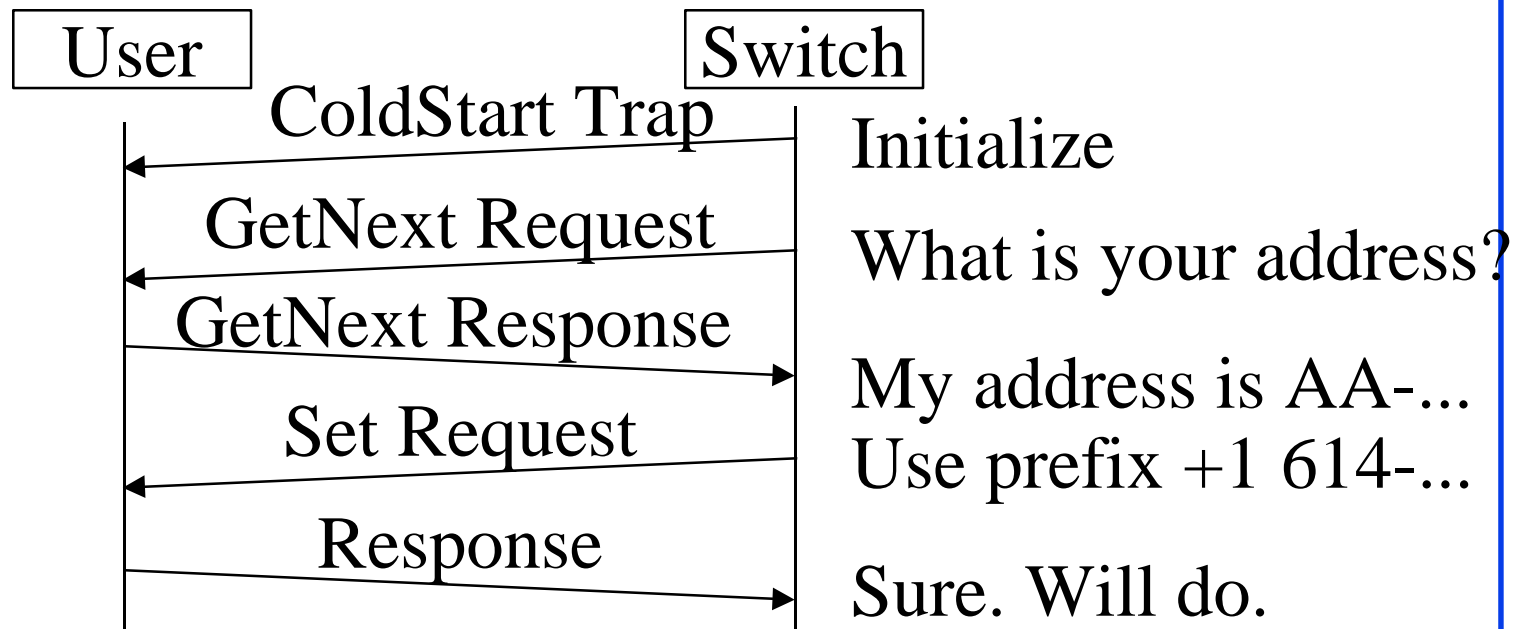

- Similar activities can occur in the reverse direction.

Connection Types

- ❑ Permanent and Switched
- ❑ Point to point
 - Symmetric or asymmetric bandwidth (Uni- or bi-directional)
- ❑ Point-to-multipoint: Data flow in one direction only. Data replicated by network.
 - Leaf Initiated Join (LIJ) or non-LIJ

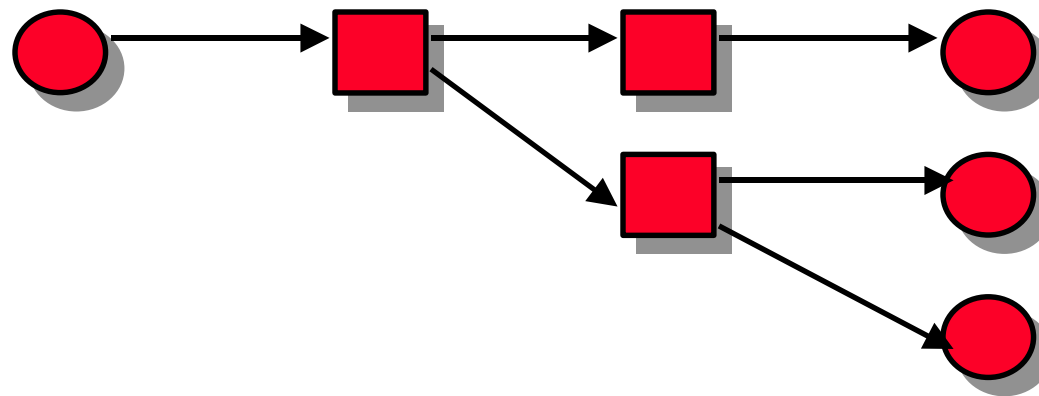

Connection Setup

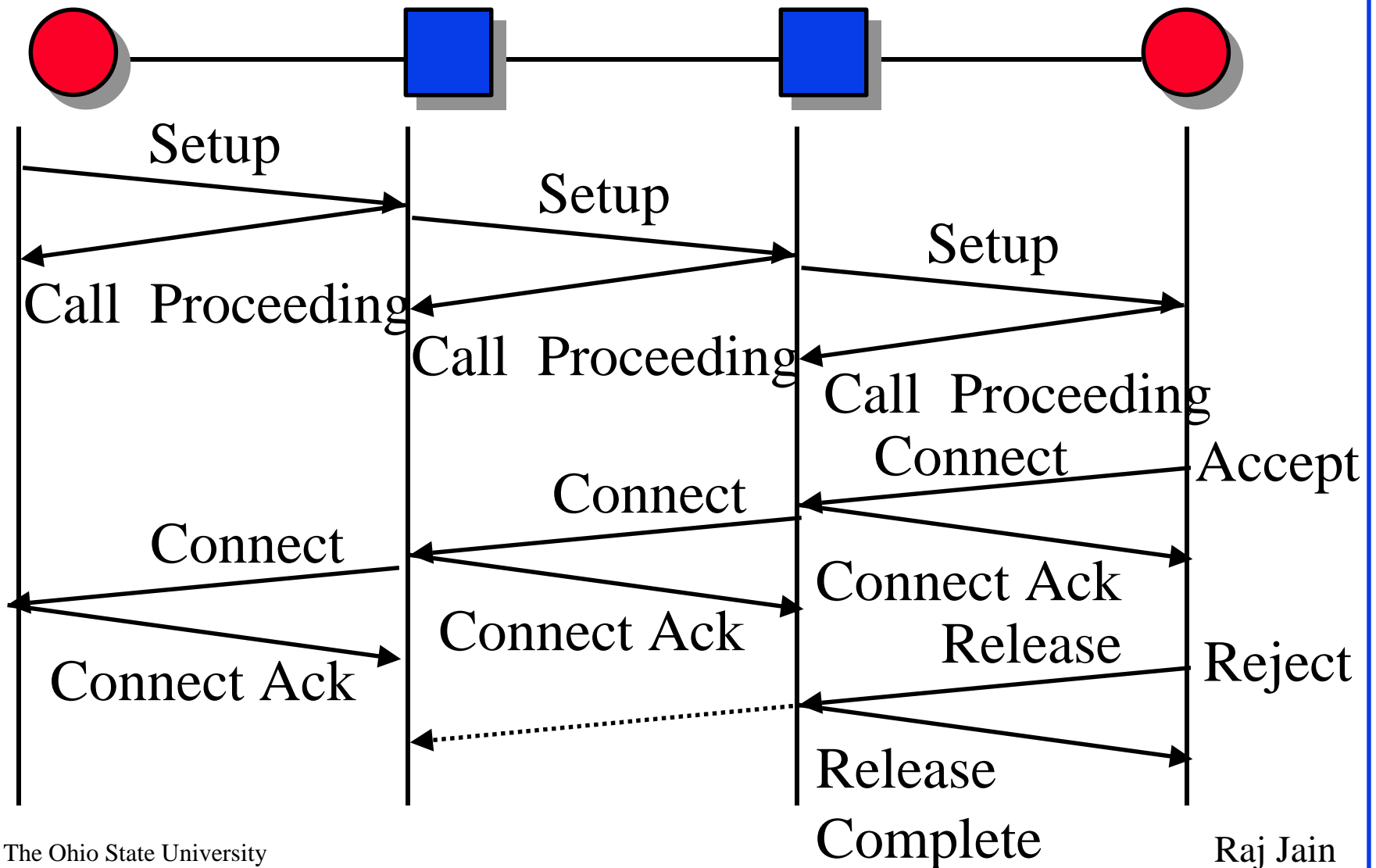

Connection Release

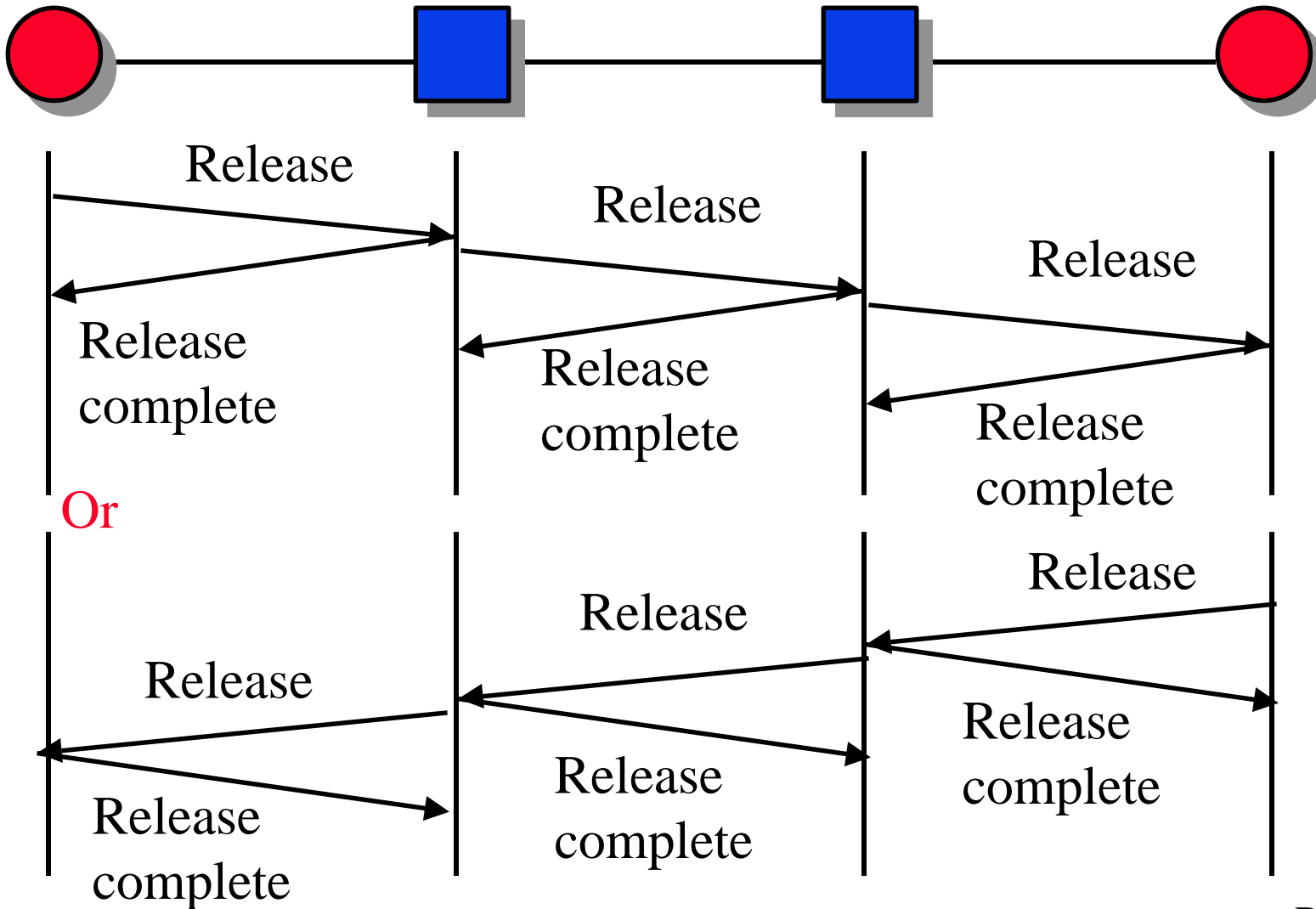

Connection Release (cont)

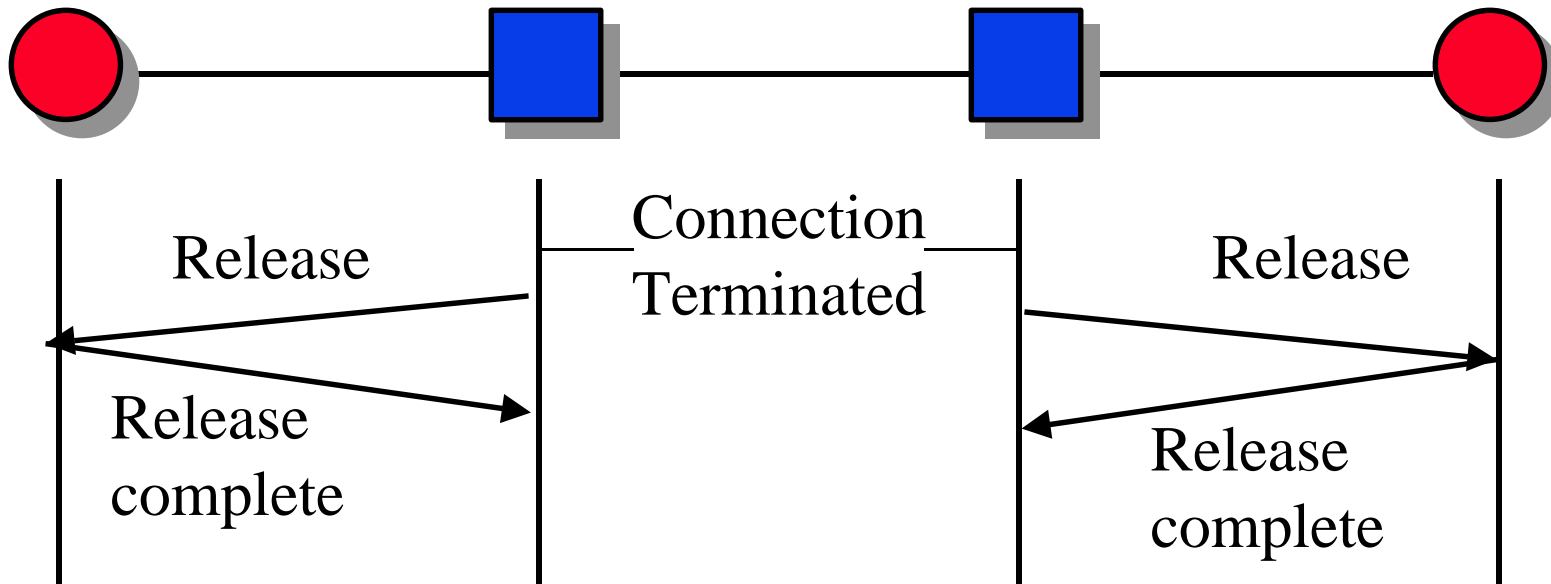

Multipoint Setup



1. Connect to the first party

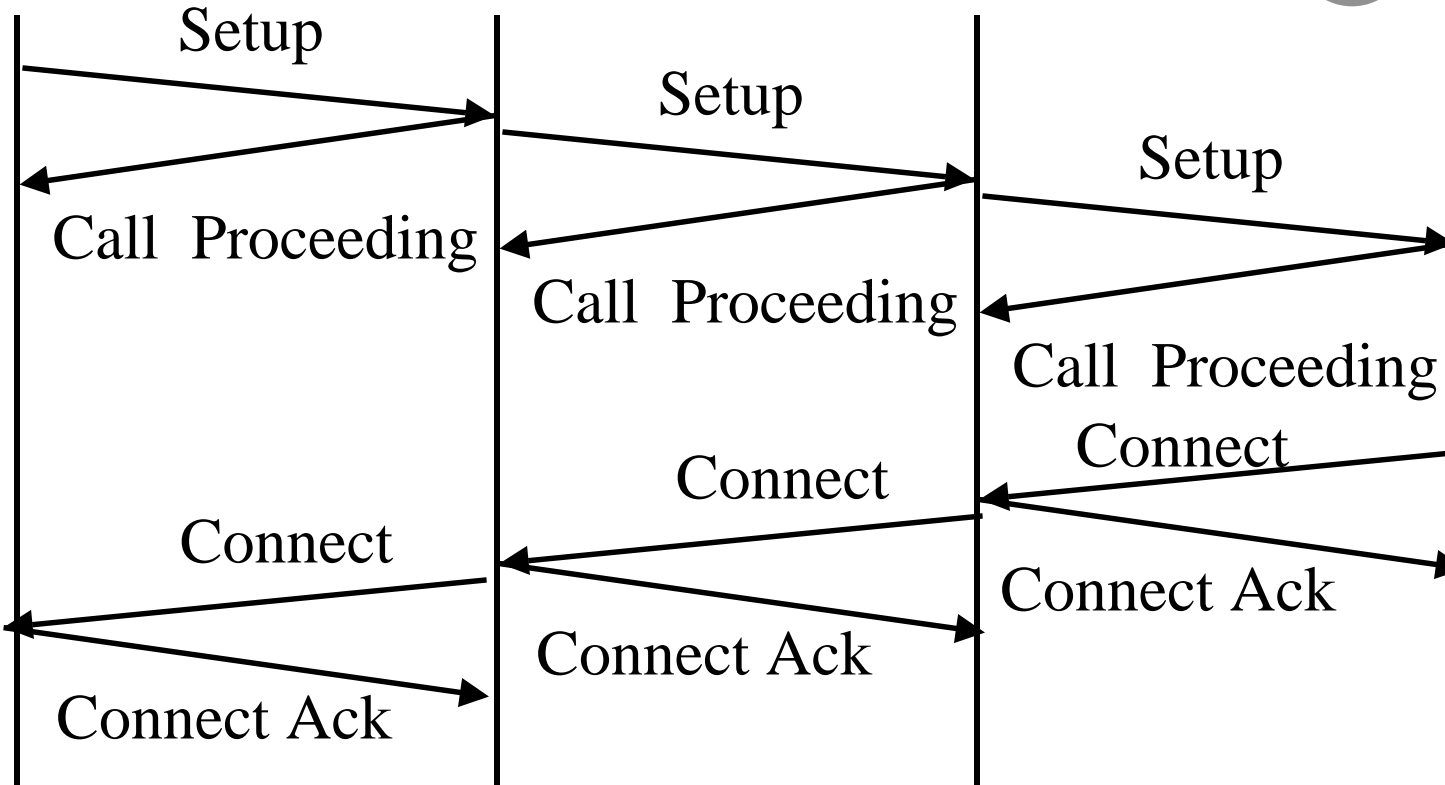

Multipoint Setup (Cont)

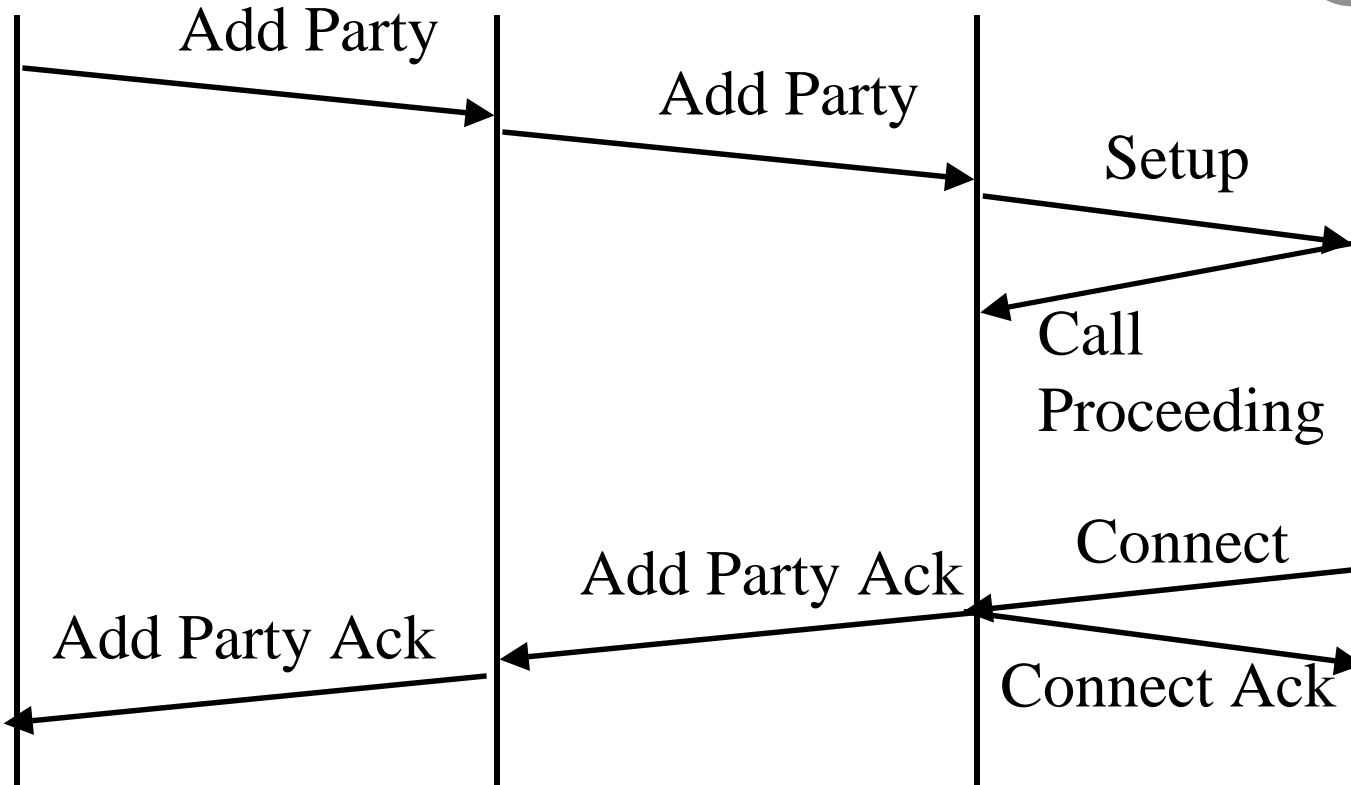
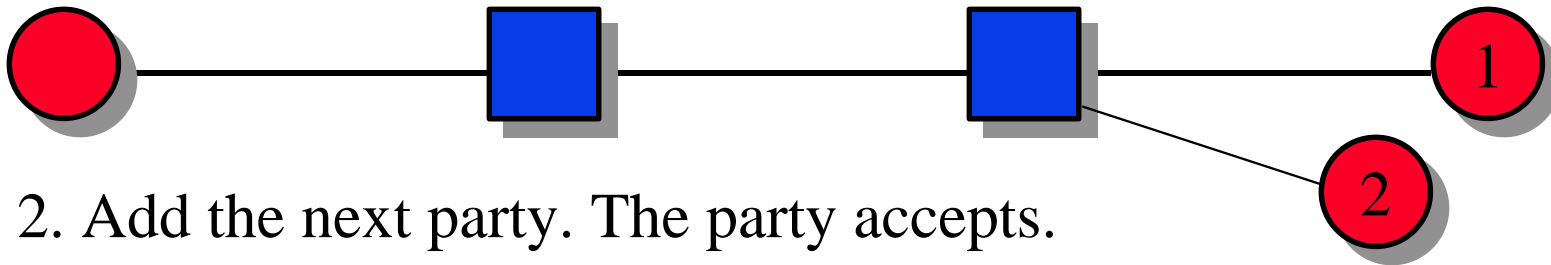

Multipoint Setup (Cont)

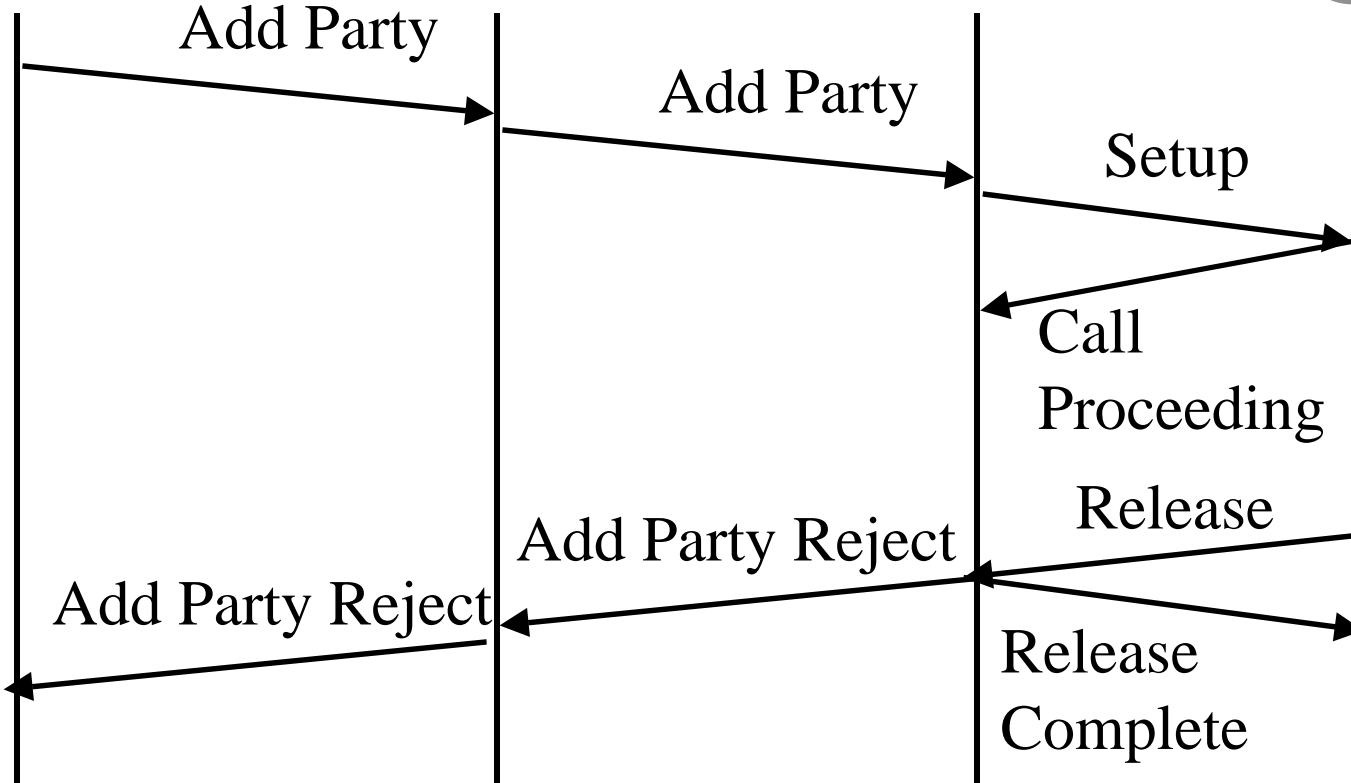

Multipoint Conn. Release



1. Root Drops a party

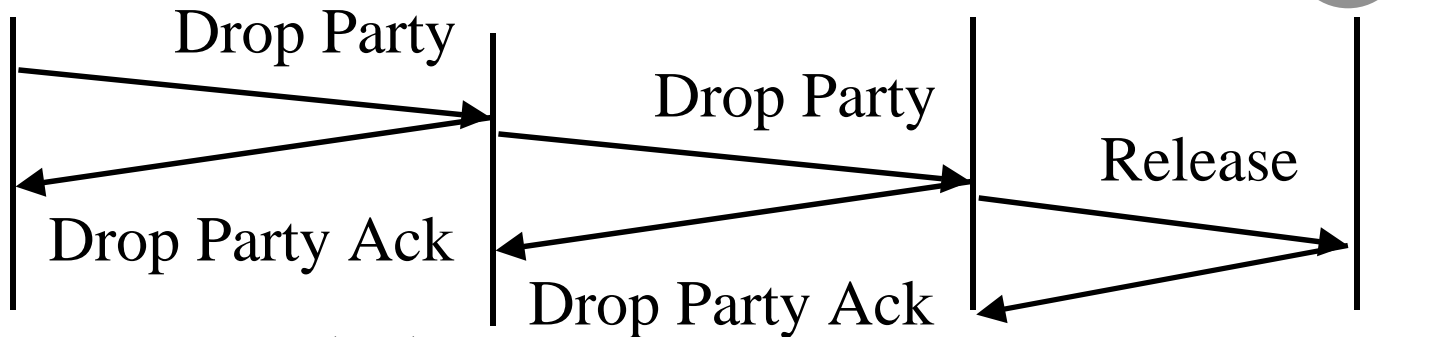

2. Root Drops the last party

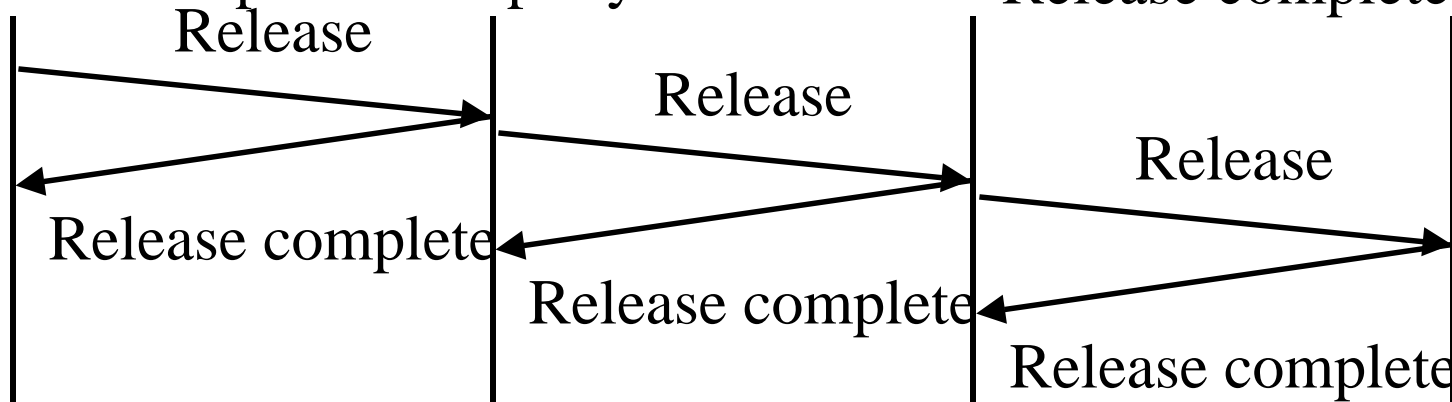

Multipoint Release (Cont)

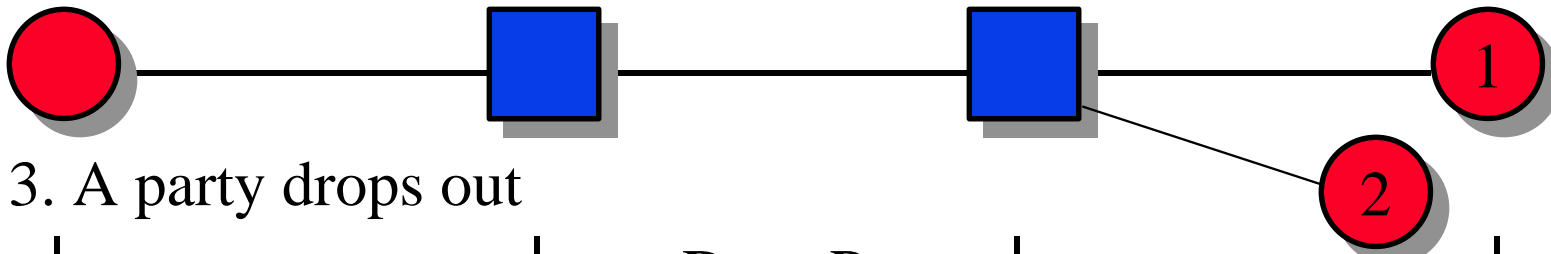

3. A party drops out

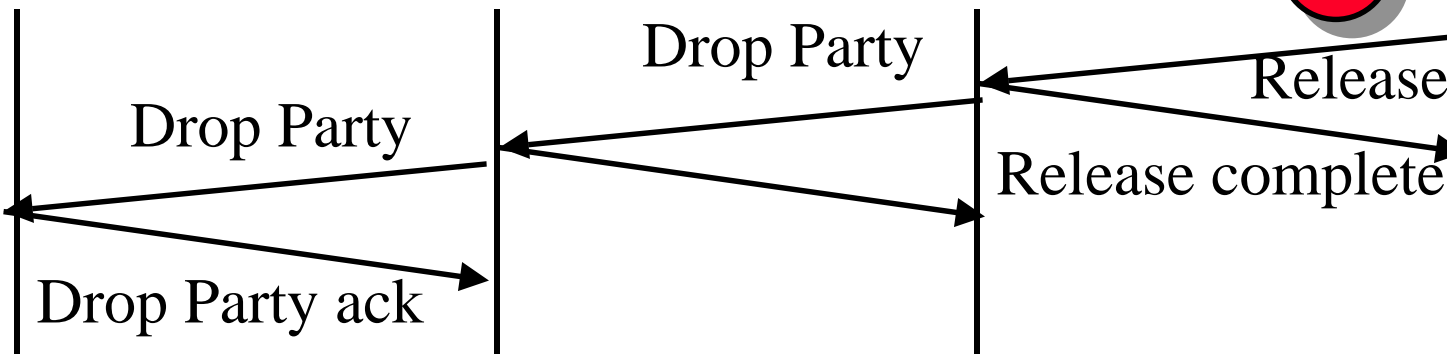

4. Network clears the call

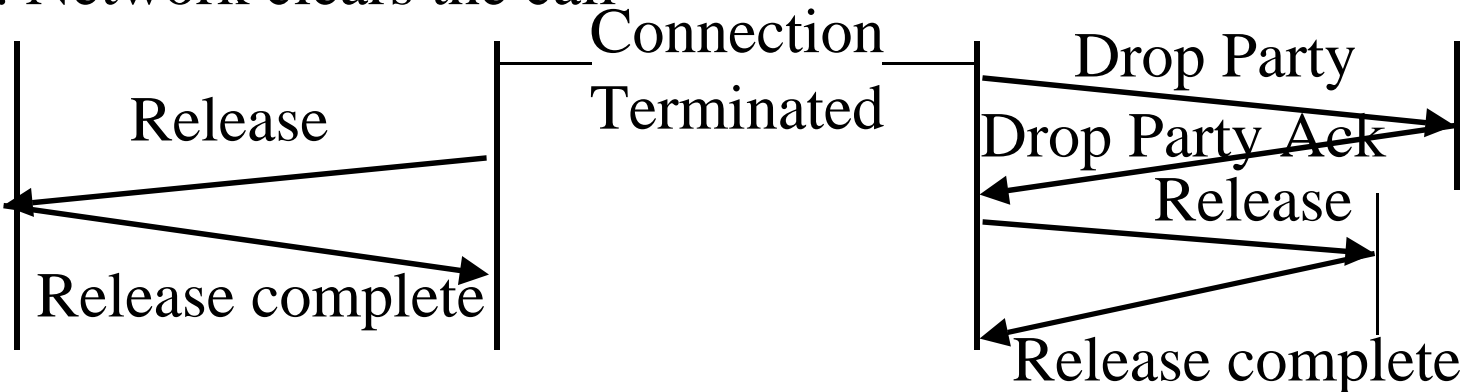

Leaf Initiated Join (LIJ)



1. Root sets up a Network LIJ call
The setup message contains LIJ parameters

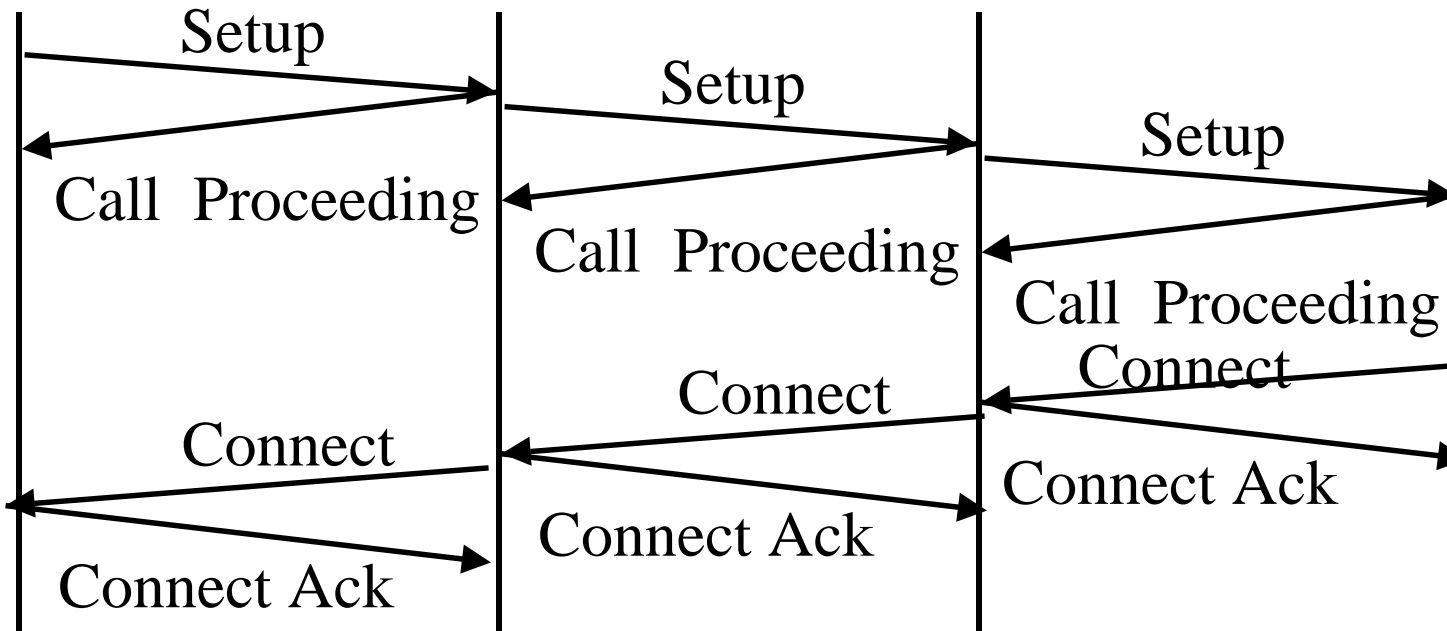

Leaf Join to an Active Call

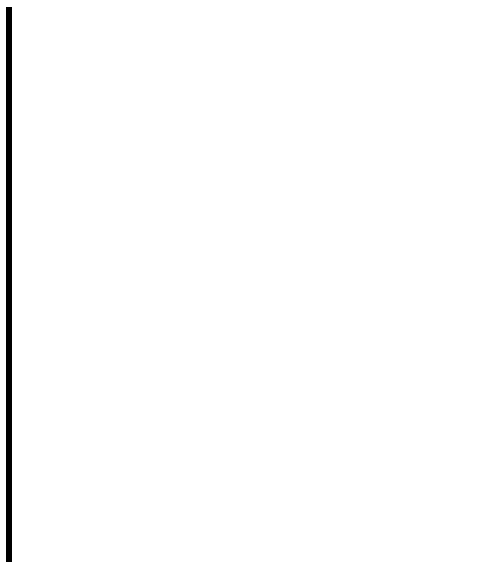
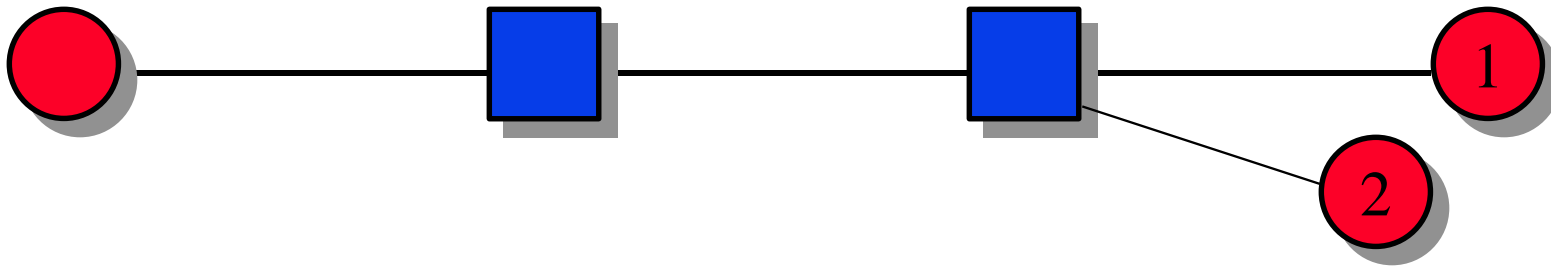

No root notification

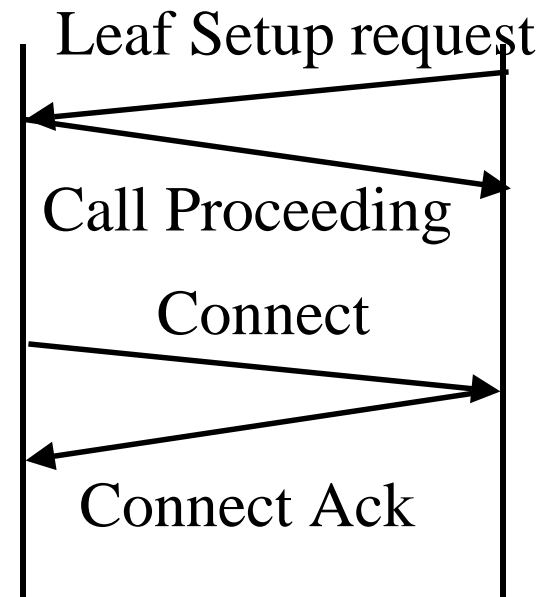

Leaf Join to an Inactive Call

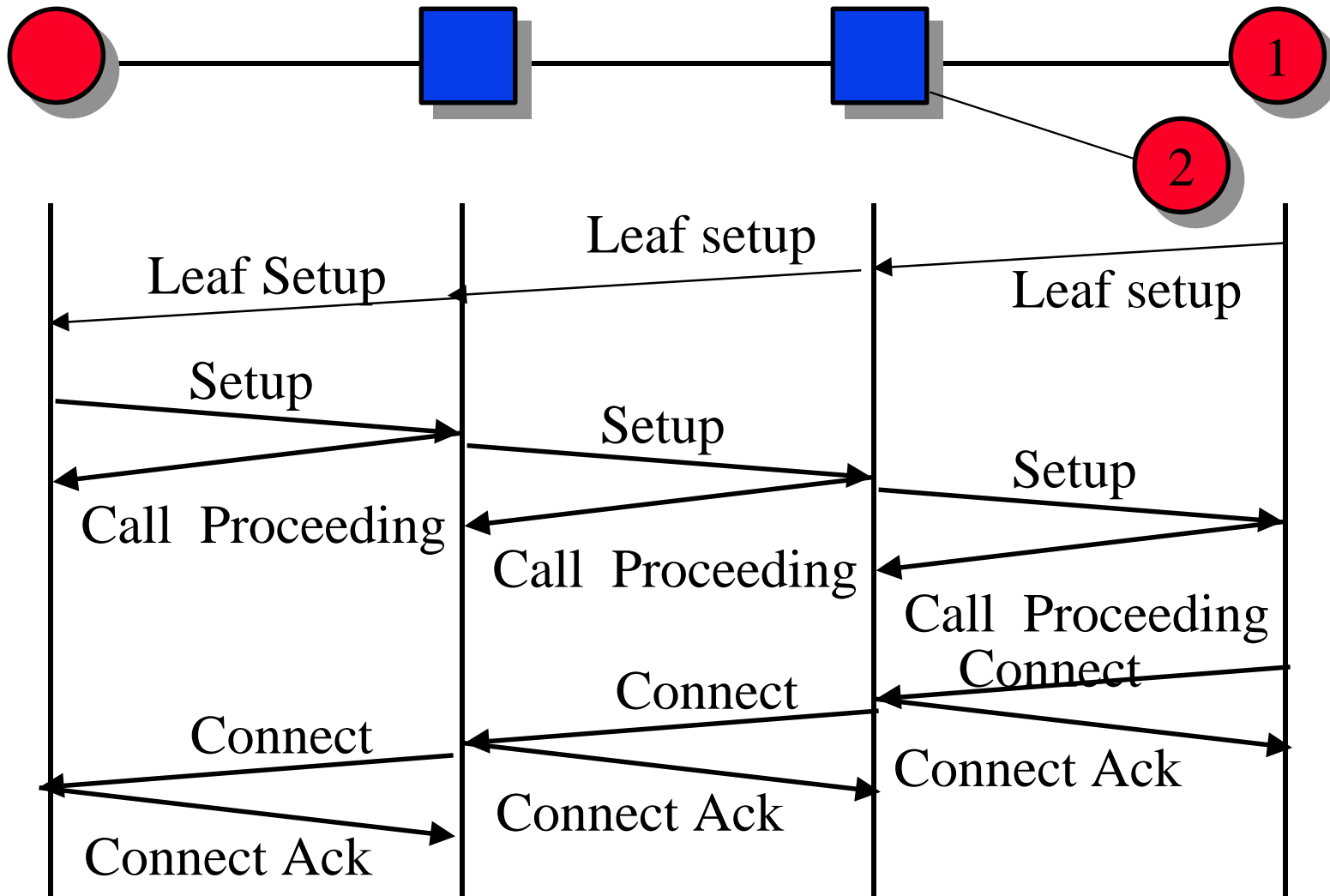

Leaf Join to a non-LIJ Call

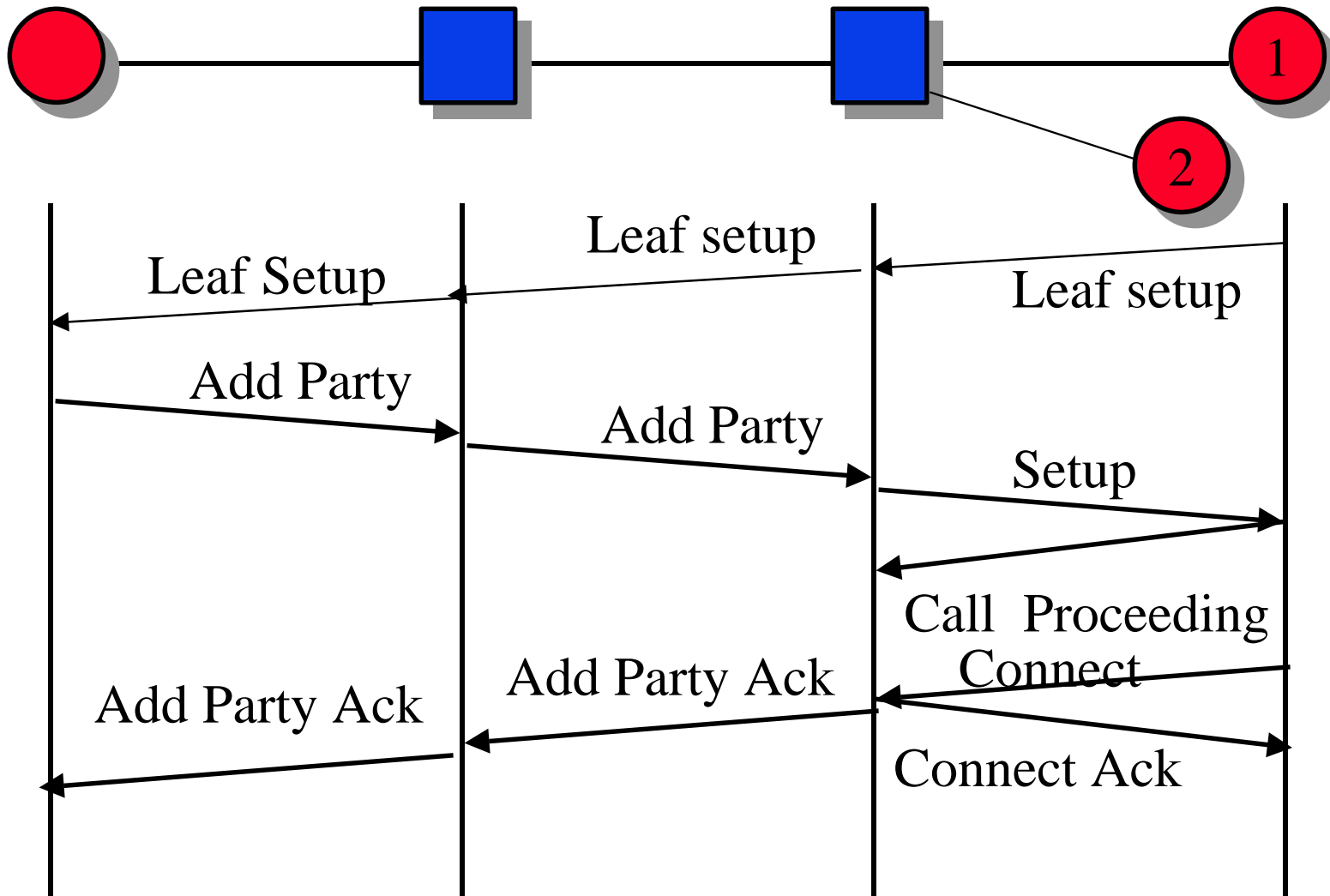

Message Format: Q.2931

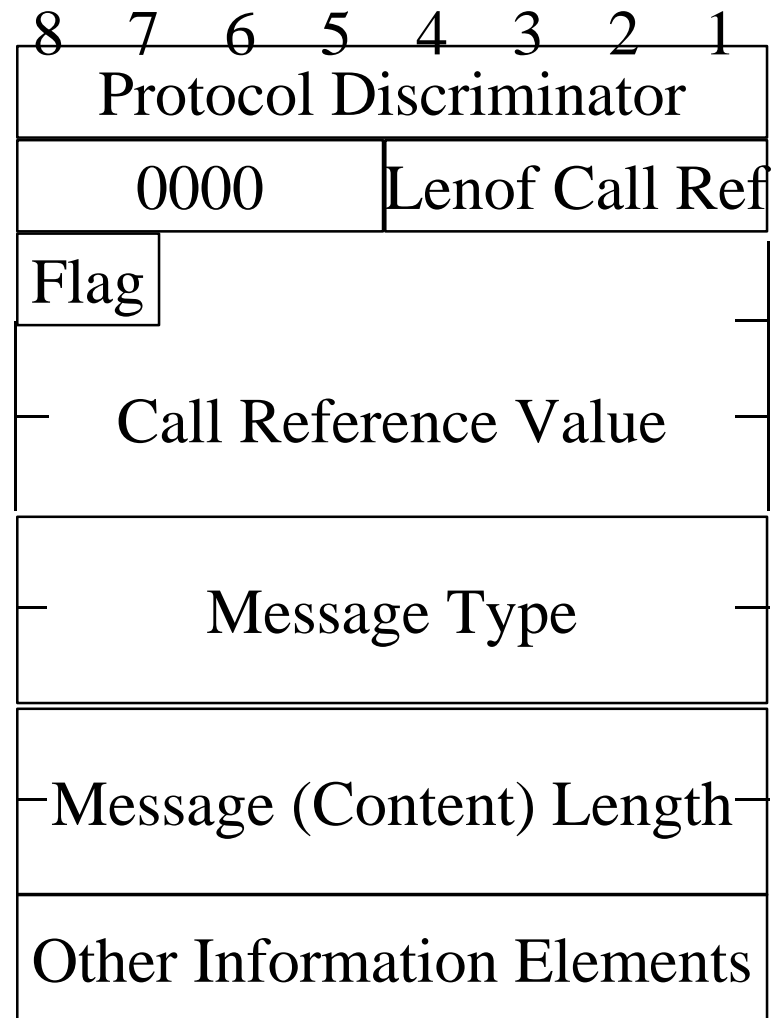

Message Format

- ❑ Protocol Discriminator (1 Byte) = Distinguishes Q.2931 messages from other messages
08 = Q.931 09 = Q.2931
- ❑ Call reference (4 bytes) : Identifies call to which this message is related to. One user may have many calls simultaneously.
 - Flag = 1 Message is from call reference originator
 - Flag = 0 Message is to call reference originator
- ❑ Message Type (2 Bytes): Many types, e.g., connect, call proceeding, setup, release, etc.
- ❑ Message Length (2 Bytes): Length of contents

Sample Message Types

Bits 876	Bits 54321	Type
000		Call establishment messages
	00010	Call proceeding
	00111	Connect
	01111	Connect Ack
	00101	Setup
	01101	Setup Ack
010		Call Clearing Messages
	01101	Release
	11010	Release complete
011		Information
	10101	Status Inquiry
	11101	Status
111		Reserved for extension

Information Element Formats

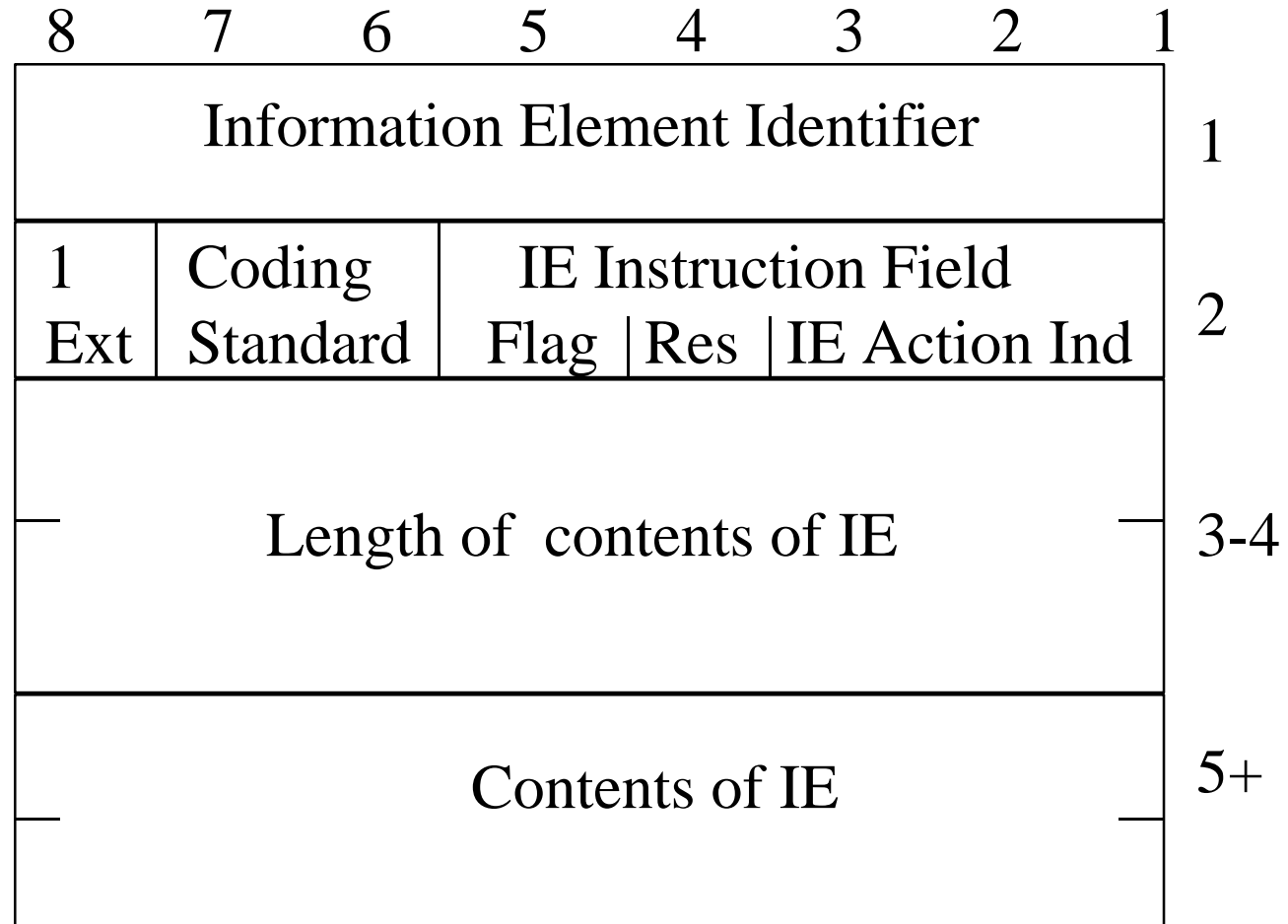

Sample Information Elements

Bits 87654321	Information Element
01110000	Called party number
01110001	Called party subaddress
01111000	Transit network selection
01101100	Calling party number
01101101	Calling party subaddress
01011000	AAL parameter
01011001	ATM Traffic Descriptor
01011010	Connection Identifier
01011100	Quality of Service Parameter
01000010	End-to-end transit delay
01011110	Broadband bearer capability

Bandwidth Contract

- User specifies 12 leaky bucket parameters

	Forward	Backward
CLP=0	Peak Cell Rate Sustainable Cell Rate Maximum Burst Size	Peak Cell Rate Sustainable Cell Rate Maximum Burst Size
CLP=0+1	Peak Cell Rate Sustainable Cell Rate Maximum Burst Size	Peak Cell Rate Sustainable Cell Rate Maximum Burst Size

Protocol Stacks

- Signaling AAL (SAAL)
 - Service specific coordination function (SSCF):
Provides interface to Q.2931
 - Service specific connection-oriented protocol (SSCOP): Error and loss recovery
 - AAL Common Part (AAL CP): Error detection

	Q.2931	TCP/IP	LMI, SNMP
SAAL	SSCF Q.2130	AAL	AAL
	SSCOP Q.2110		
	AAL CP I.363		
ATM I.361			
SONET, DS1, E1, etc. I.432			

UNI 3.1 Features

- ❑ Align with Q.2931
- ❑ Use new version of SSCOP

UNI 4.0 Features

- ❑ Point-to-point and point-to-multipoint calls
- ❑ Leaf initiated join capability
- ❑ Notification of end-to-end connection completion
- ❑ ATM Anycast capability
- ❑ Multiple signalling channels
- ❑ Switched virtual path service
- ❑ Proxy signaling
- ❑ Frame discard capability
- ❑ ABR signaling for point-to-point calls
- ❑ Traffic parameter negotiation

Summary

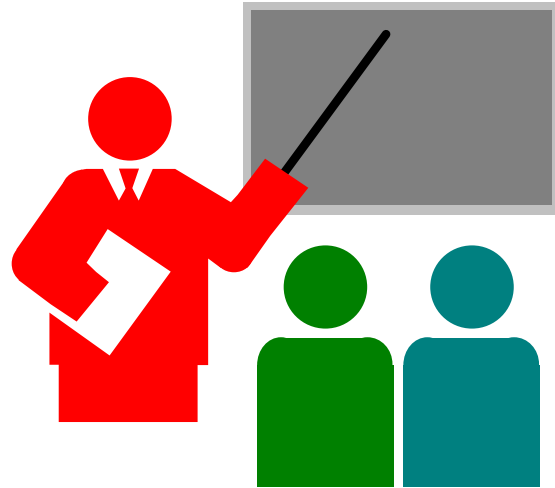

- ❑ NSAP address formats
- ❑ Call setup and release: Point-to-point, point-to-multipoint, Leaf-initiated join
- ❑ Q.2931 Message formats and information elements
- ❑ Traffic contracts

References

- ❑ D. Minoli and G. Dobrowski, “Principles of Signaling for cell relay and frame relay,” Artech House, 1995, 305 pp.
- ❑ RFC 1237, “Guidelines for NSAP allocation in the Internet”
- ❑ ATM User-Network Interface Signalling Specifications v4.0 (Jul 1996),
<ftp://ftp.atmforum.com/pub/approved-specs/af-sig-0061.000.doc> (1050 kB)

B-ISDN

Recommendations

- ❑ E.164 Numbering plan for the ISDN era
- ❑ I.113 B-ISDN vocabulary of terms
- ❑ I.150 B-ISDN ATM Functional Characteristics, 1993
- ❑ I.211 B-ISDN Service Aspects, 1993
- ❑ I.311 B-ISDN General Network Aspects, 1993
- ❑ I.321 B-ISDN Protocol Reference Model and Its Application, 1993
- ❑ I.327 B-ISDN Functional Architecture, 1993
- ❑ I.361 B-ISDN ATM Layer Specification, 1993

- ❑ I.362 B-ISDN ATM Adaptation Layer (AAL) Functional Description, 1993
- ❑ I.363 B-ISDN ATM Adaptation Layer (AAL) specification, 1993
- ❑ I.413 B-ISDN User-Network Interface, 1993
- ❑ Q.2110 B-ISDN SAAL Service Specific Connection Oriented Protocol (SSCOP)
- ❑ Q.2130 B-ISDN SAAL Service Specific Coordination function (SSCF)
- ❑ Q.2610 B-ISDN Usage of Cause and Location in B-ISDN user part and DSS2

- ❑ Q.2931 B-ISDN DSS2 User-network Interface (UNI) Layer 3 Specification for Basic call/connection control
- ❑ Q.2951 Stage 3 description for number identification supplementary services using B-ISDN DSS2 Basic Call
- ❑ Q.2961.1 B-ISDN DSS2 Negotiation/Modification: Additional Traffic Parameter Indications
- ❑ Q.2962, Negotiation of traffic and QoS parameters (during call/connection establishment)

- ❑ Q.2963, Renegotiation/modification of traffic and QoS parameters (for already established calls/connections)
- ❑ Q.2964, B-ISDN look-ahead
- ❑ Q.2971 B-ISDN DSS2 UNI Layer 3 Specificatin for Point-to-multipoint Call/connection control
- ❑ Q.298x, Multiconnection calls